

**TRIPLE K
IRRIGATION**



**Manure
& Irrigation
Handling
Equipment**



6th Volume

(517) 458-9741

www.IrrigationSupplyParts.com

Please visit our website for more information:

Secure | <https://www.irrigationsupplyparts.com>

Call Us Today! 517-458-9741 | info@irrigationsupplyparts.com

[About Us](#)

[My Account](#)

[CART](#) ▾



[PRODUCT CATEGORIES](#)

[FEATURED PRODUCTS](#)

[NEWS & EVENTS](#)

[CONTACT](#)



Search...

IRRIGATION SUPPLY CATEGORIES

- Aluminum Tubing Fittings
- Camlock Couplings & Fittings
- Clamps
- Drip Irrigation
- Fabrication Fittings
- Filters
- Garden Drip Irrigation Kits
- Gaskets
- Gauges
- Hose Connections
- Hoses - Suction & Discharge
- Lever Loc Fittings
- Malleable Iron Fittings
- Manure Management Equipment
- Primers
- PVC Fittings
- Sprinklers
- Suction & Discharge Parts
- Repair Couplers
- Valves
- Clearance / Closeouts

ORDERS BY 3PM - SHIP SAME DAY

Sort by [Default Order](#) ▾ | Show 28 Products ▾



Secure | <https://www.facebook.com/IrrigationSupplyParts/>

Triple K Irrigation

Home

Triple K Irrigation
@IrrigationSupplyParts

Home

Posts

Reviews

Photos

Shop

Offers

Groups

Community

Videos

Events

About

Write something...

Triple K Irrigation
October 23 at 4:38pm · 🌐

It's #MotivationalMonday. Triple K Irrigation knows you're hard working and depend on nature for your next successful days. Stick with us to provide quality products and savings directly to your family. Call 517-458-9741 or visit www.irrigationsupplyparts.com for more information.

Agricultural Service in Morenci, Michigan
5.0 ★★★★★ · [Open Now](#)

About [See All](#)

12930 Ingall Hwy
Morenci, Michigan 49256

(517) 458-9741

Typically replies within an hour
[Send Message](#)

<http://www.irrigationsupplyparts.com>

Agricultural Service · Business Service · Agriculture Company

Hours 8:00AM - 5:00PM
[Open Now](#)

Visit our Facebook page for more information and special product promotions!

Being a farmer means shaking hands with nature

To Past, Present and Future Customers,

Welcome to the 6th volume of our product catalog as well as our 18th year as Triple K Irrigation! We are excited to offer many new products to assist you with your growing needs. Please check out our online store too at www.IrrigationSupplyParts.com. We hope you find both the catalog and online store useful. As always, we will strive to ship orders the same day if received by 3:00 pm EST. If you should have any further questions, feel free to call us to help assist you.



SALES TERMS
MASTERCARD, VISA, AMERICAN EXPRESS, DISCOVER,
C.O.D. or CHECK in advance.

Leasing available upon request. All returns for credit MUST include invoice and will have a 15% restocking charge. No return for special order items. Finance charges are calculated on all past due unpaid invoices at the rate of 1.5% per month (18% per year) or the maximum allowed by law.

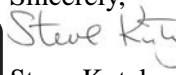
Sincerely,

 Steve Kutzley

Triple K Irrigation Inc
 12930 Ingall Highway
 Morenci, MI 49256
 517-458-9741

PRODUCT INDEX

<i>PRODUCT DESCRIPTION</i>	<i>PAGE</i>	<i>PRODUCT DESCRIPTION</i>	<i>PAGE</i>
ALUMINUM TUBING ACCESSORIES		GAUGES	
Band & Latch Fittings.....	25	Murphy Gauges.....	34
Band & Latch Parts.....	6	Pressure Gauges.....	3, 34
Ringlock Fittings.....	25	HARD HOSE IRRIGATION TRAVELERS.....	20
Gaskets (Replacement).....	35	HOSE END COUPLERS	
Aluminum Fabrication Fittings.....	26	Band & Latch Couplers.....	27
Aluminum Tubing.....	40	Bauer Type "A" & "B" Style Couplers.....	15, 16
BANJO FITTINGS.....	22, 23	Doda Style Coupler.....	16
BAUER TYPE COUPLINGS ("A" & "B" Style)...	15, 16	Ringlock Coupler.....	27
CAMLOCKS		Shug Grip Coupler.....	4
Aluminum Camlock Fittings.....	24	HOSE REPAIR COUPLERS	
Banjo Fittings.....	22, 23	Layflat Insert Coupler.....	29
CLAMPS		PE Tube Mender (For Polyethylene).....	28
Band-It Center Punch Clamps & Tool...	17, 24	Shug Grip Repair Coupler & Mender.....	4, 29
Band & Latch Clamps.....	19	Steel Hose Mender.....	29
Double Bolt Clamps.....	19	Traveler Soft Hose Mender.....	29
Ringlock Bolt On Clamps.....	27	HOSE & PE TUBE REPAIR INSTRUCTIONS.....	
Ringlock Clamps.....	19	HOSES	
Single Bolt Clamps.....	19, 24	Discharge Hose.....	15, 24
Spiral Bolt Clamps.....	19	Drag Hose.....	17, 18
Victaulic Clamps.....	19	MainlineHose.....	17, 18
Worm Gear Clamps.....	19	Multi-PurposeAir/WaterHose.....	1, 17, 18
Shug Grip Coupler Clamps - 3 Piece.....	4, 19	Oval Hose.....	49
Shug Grip Coupler Clamps - Ringlock.....	4, 19	SuctionHose.....	17, 24
DODA COUPLINGS.....	16	Traveler Hose.....	17
DRIP IRRIGATION		IRRI-GATOR DRIP IRRIGATION GARDEN KITS..	
Drip Irrigation Fittings.....	47, 48	42	
Drip Irrigation Tubing.....	45, 48, 49	MANURE EQUIPMENT	
FABRICATION PARTS		AirHose.....	1, 18
Aluminum Fabrication Fittings.....	26	Bauer Type "A" & "B" Style Couplers.....	15, 16
Steel Fabrication Fittings.....	4, 5, 6	Brass MZ Slide Valves.....	11
Steel Schedule 10 & 40 Fittings.....	5	Clean Out Balls.....	2
Universal Catch.....	6	DragHoses.....	17, 18
FERTILIZER INJECTOR.....	43	Fabrication Fittings.....	5, 6
FILTERS.....	44, 45	Gauge Protectors.....	3
FLANGES		Hard Hose Irrigation Travelers.....	20
Aluminum Flanges.....	26	Hose Caddies.....	20
Cast Iron Companion Flanges.....	5	Hose Pinchers.....	3
MZ Valve Flanges.....	5, 11, 13, 14	MainlineHoses.....	17, 18
PVC Flanges (VanStone Style).....	5	Pumps.....	20, 21
Steel Flanges.....	5, 11	Shug Grip Fittings.....	4
FLOW METERS.....	1, 23, 43	Strainers.....	3
FOOT VALVES & PARTS.....	30, 31	Tile Plugs / Pipe Sealing Plugs.....	2
GASKETS		12-Volt Power Primer.....	3, 7, 8
Aluminum Tubing Gaskets.....	35	PIPE FITTINGS	
Bauer Type Gaskets/O-Rings.....	15, 16	Aluminum Couplings.....	26
Camlock Replacement Gaskets (BUNA)....	24	Aluminum Nipples.....	26
Compression Gaskets (Triple Lip).....	37	Malleable Iron Fittings.....	36
Doda Gaskets.....	16	Steel Couplings.....	6
Flange Gaskets.....	5, 11	Steel Nipples.....	6
MZ Valve Gaskets.....	5, 11, 13, 14	Zinc Alloy Fittings.....	33
Shug Grip Coupler Gaskets.....	4	PRIMERS	
		12-Volt Power Primer.....	3, 7, 8

(continued)



2" & 3" Mandals Mantex High Pressure Air Hose

2"

.55 lbs/ft

600 PSI Pressure Rating

2535 Burst Pressure Rating

Wall Thickness .17 in

Tensile Strength 31,700 lbs

3"

1.2 lbs/ft

375 PSI Pressure Rating

1500 Burst Pressure Rating

Wall Thickness .18 in

Tensile Strength 46,600 lbs

25' and 5' Lengths with Dixon GJ Boss Female Coupling with Polymer Seat, Plated Iron – IN STOCK!

See Pages 17 and 18 for Additional Hose Options.

CHERNE PNEUMATIC PLUG

(PIPE SEALING PLUGS)

The Muni-Ball Plug was introduced over 50 years ago and the Cherne brand continues to be the most trusted name in pneumatic plugs. Muni-Ball Plugs offer a full bypass allowing both testing and monitoring of piping systems. Muni-Balls are ideal for installation and repair of residential or commercial piping systems.

Muni-Ball plugs are durable, rugged and are effective on almost any type of pipe.

Muni-Ball Plugs are supplied with Schrader tire inflation valves.

Part#	Size / Description
128-310088	4" - 8"
128-310128	6" - 12"
128-310168	8" - 16"
128-310248	12" - 24"
128-310328	15" - 32"
128-383208	Poly Lift Line w/ Gauge - 20'



CLEAN OUT BALLS - SOFT DENSITY

MADE IN THE USA

Part#	Size	Description
125-CBLSCO-175	175MM	BLUE
125-STM-0176-F-1	176 MM	ORANGE
125-CBLSCO-250	250MM	ORANGE
125-CBLSCO-270	270MM	ORANGE
125-CBLSCO-300	300MM	ORANGE
125-CBLSCO-355	355MM	ORANGE

ECONOMY BRAND
NOT CHINA BRANDED

Part#	Size
57-COBS40VP	120MM
57-COBS87	220MM
57-COBS106	270MM
57-COBS120	305MM



SIZE CHART

Hose Size	MM Size
4"	120MM
5-6"	175-176MM
6-8"	175-270MM
10"	305MM
12"	355MM

CHERNE PNEUMATIC PLUG

The Cherne Test-Ball has been the contractor's choice for over 50 years and continues to be the most trusted pneumatic test ball in the industry. Designed for applications from pressure testing and blocking of residential DWV systems to repair maintenance and installation of municipal infrastructure.

All Test-Balls are bendable to 90 degrees.

Test-Balls 15-30" size and larger now include our Rupture Disc Technology. This feature prevents over-inflation of the pneumatic plug.

Part #	Size
128-270040	4"
128-270067	6"
128-041386	8"
128-041394	10"



Floor Drain



Floor Drain



POLY-LIFT LINE WITH GAUGE

- Retard gauge: helps prevent "peg-out" damage
- Heavy-duty rubber gauge cover protects gauge face
- 3/8" ID hose for quick inflate/deflate
- Quick-dump valve for easy deflation
- Quick disconnect design for easy installation
- Designed for use with plugs with removable inflation valve and eye bolt



Part#	Length
128-261398	20'

KROHNE FLOW METER

Krohne has been developing flow and level measurement products for over 75 years. The first choice for flow meters, Krohne electromagnetic flow meters are used in water and wastewater industries. From liquid to slurries, they can provide precision flow measurements. You can select from among the industry's largest assortment of liner / electrode choices to match your application.



LIQUID-FILLED PSI GAUGE

GLYCERINE-FILLED FOR LONG LIFE



Part#	PSI Range
111-LPG30	0-30 PSI
111-LPG060	0-60 PSI
111-LPG100	0-100 PSI
111-LPG160	0-160 PSI
111-LPG200	0-200 PSI
111-LPG300	0-300 PSI

MISCELLANEOUS GAUGES



Part#	Description
10-SEG-201L-254A	Liquid Fill Vacuum Gauge 30-0
10-VIG-015	2.5" Liquid Gauge 15 PSI
10-VIG-100	2.5" Liquid Gauge
143-IPG10045-4L	Pressure Gauge STL 100# 4.5D 1/4LM
143-IPG30045-4LNL	Pressure Gauge STL 300# 4.5 D 1/4LM LN

MANURE STRAINER SCREEN GALVANIZED WITH 2" OPENING



Part#	Size
22-Strainer6OD	6"
22-Strainer858OD	8-5/8"

GAUGE PROTECTOR KIT (FOR HEAVY SOLIDS)



Part #
20-M3GAU-PROTEC

GAUGE PROTECTOR KIT (FOR GREY WATER)



Part #
121-BAAF

HOSE PINCHER FOR 6"-8" HOSE



Part #
100-6"-8" Hose Pincher

CLOG-BUSTER DRAIN FLUSHER



Part #	
38-303127	1"-2"
38-303135	1 1/2"-3"
38-303143	4"-6"
38-006193	Faucet Adapter

12 VOLT POWER PRIMER

FOR MORE PRIMER INFORMATION AS WELL AS A SCHEMATIC AND REPLACEMENT PARTS LIST PLEASE SEE PAGES 5 AND 6.



Part# 100-12VoltPrimerAssembly

SHUG GRIP MENDER SET 

Part #	Size
20-M3MCS4A	4"
20-M3MCS45A	4.5"
20-M3MCS5A	5"
20-M3MCS55A	5.5"
20-M3MCS6A	6"
20-M3MCS7A	7"
20-M3MCS725A	7.25"
20-M3MCS8A	8"
20-M3MCS10A	10"
20-M3MCS12HDA	12"

SHUG GRIP MAIN / DRAG COUPLER SET 

Part #	Size
20-M3CS4A	4"
20-M3CS45A	4.5"
20-M3CS5A	5"
20-M3CS55A	5.5"
20-M3CS6A	6"
20-M3CS7A	7"
20-M3CS8A	8"
20-M3CS8HDA	8"
20-M3CS8HDSA	8"
20-M3CS10A	10"
20-M3CS10HDSA	10"
20-M3CS12HDA	12"
20-M3CS12HDSA	12"

SHUG GRIP COUPLER DOUBLE-BOLT 3-PIECE CLAMP 

Part #	Size
20-M3SEG45-3A	4.5"
20-M3SEG5-3A	5"
20-M3SEG55-3A	5.5"
20-M3SEG6-3A	6"
20-M3SEG7-4A	7"
20-M3SEG8-4A	8"
20-M3SEG10-5A	10"

SHUG GRIP ADAPTER (F x F) 

Part	Size
20-M3AFF68A	6"x8"
20-M3AFF810A	8"x10"

SHUG GRIP ADAPTER (M x M) 

Part #	Size
20-M3AMM68A	6"x8"
20-M3AMM810A	8"x10"

MALE RINGLOCK x MALE SHUG COUPLER ADAPTER 

Part #	Size
58-HSGA6M	6"

FEMALE RINGLOCK x MALE SHUG COUPLER ADAPTER 

Part #	Size
58-HSGA6F	6"

SHUG GRIP COUPLER HD RING CLAMP 

Part	Size
20-M3CL6	6"
20-M3CL8	8"
20-M3CL10	10"
20-M3CL12	12"

SHUG GRIP COUPLER SLEEVE 

Part #	Size
20-M3SLV6A	6"
20-M3SLV8A	8"
20-M3SLV10A	10"
20-M3SLV12A	12"

SHUG GRIP COUPLER GASKET 

Part	Size
100-IPS5	6"
13-103835	8"
20-M3GSK10	10"

SHUG GRIP COUPLER WELD-ON HOSE BARB 

Part #	Size
100-SWOHB4	4"
100-SWOHB6	6"
100-SWOHB8	8"

MALE WELD-ON SHUG GRIP COUPLER 

Part	Size
100-HSGW2	6" Steel
100-HSGW28	8" Steel

MALE WELD-ON FLARED SHUG GRIP COUPLER 

Part #	Size
20-M3AWOFM55	4" - 6"
20-M3AWOFM8	7" - 8"
20-M3AWOM10	10"

SHUG GRIP COUPLER WELD-ON STEEL RINGS 

Part	Size
100-PHSG106	6"
100-PHSG108	8"

SHUG GRIP COUPLER SINGLE-WIDE 3-PIECE CLAMP 

Part #	Size
100-3P4	4"

FEMALE WELD-ON SHUG COUPLER 

Part #	Size
100-HSGW1	6" Steel
100-HSGW18	8" Steel
20-M3AWOF10	10" Steel

SHUG GRIP COUPLER MISC PARTS 

Part #	Description
88-0120712	Lynch Pin
88-10007-04712	Clevis Pin
88-65026	Cotter Pin
88-73543	Socket Screw

HIGH FLOW REDUCERS 

Part #	Size
20-M3AFFHF810A	8" Female x 10.25" Female
20-M3AFMHF810A	8" Female x 10.25" Male
20-M3AMMHF810A	8" Male x 10.25" Male

HIGH FLOW CLAMPS 

Part #	Size
20-M3CL10HF	10.25" HF Clamp Set
20-M3CL10HFSDS	10.25" HD Steel Swivel Clamp

HOSE SAVER CLAMP 

Part #	Size
20-M3CL8SHDS	8" HD Steel
20-M3CL10SHDS	10" HD Steel

WELD ON ADAPTER 

Part #	Size
20-M3AWOFHF10	10.25" Female Weld Neck
20-M3AWOFHFM10	10.25" Male Flared

HIGH FLOW COUPLERS 

Part #	Description
20-M3CSHF10A	10.25" HF w/ Standard Clamp (Set Screws)
20-M3CSHF10HDSA	10.25" HF w/ SHDS Hose Saver Clamp (Bolt Style)
20-M3CSHF10SA	10.25" HF w/ SDHS Hose Saver Clamp (Set Screws)
20-M3CSHF12HDA	12.25" HF w/ Standard Clamp (Bolt Style)

90° WELDING ELBOW
(Schedule 40) 

Part #	Size
77-MN90LR11	4"
77-MN90LR12	5"
77-MN90LR13	6"
77-MN90LR14	8"
77-MN90LR15	10"

45° WELDING ELBOW
(Schedule 40) 

Part #	Size
77-MN4510	3"
77-MN4511	4"
77-MN4512	5"
77-MN4513	6"
77-MN4514	8"
77-MN4515	10"

WELDING TEE
(Schedule 40) 

Part #	Size
77-MNT11	4"
77-MNT12	5"
77-MNT13	6"
77-MNT14	8"
77-MNT15	10"

CONCENTRIC REDUCER
(Schedule 40) 

Part #	Size
77-MNCR1211	5" x 4"
77-MNCR1311	6" x 4"
77-MNCR1312	6" x 5"
77-MNCR1413	8" x 6"
77-MNCR1514	10" x 8"

INLINE WYE
(Schedule 40) 

Part #	Size
94-MNW13	6"
94-MNW14	8"
94-MNW15	10"

ECCENTRIC REDUCER
(Schedule 40) 

Part #	Size
94-MNER1413	8" x 6"
94-MNER1514	10" x 8"

90° WELDING ELBOW
(Schedule 10) 

Part #	Size
94-SCH10-90LR13	6"
94-SCH10-90LR14	8"

45° WELDING ELBOW
(Schedule 10) 

Part #	Size
94-SCH10-4513	6"
94-SCH10-4514	8"

300PSI WELD ON FLANGE



Part #	Size
77-MN300LF13	6"

300 PSI Flange Gasket

Part #	Size
153-6FF300-RR-125	6"
153-8FF300-RR-125	8"

STEEL FLANGE FOR MZ VALVE

Part #	Size
100-2005-0000	4"
100-2006-0000	6"
100-2006-0001	8"

GASKET FOR MZ VALVE

Part #	Size
72-2005.88	6"
72-2001.00	8"

 WE HAVE THE ABILITY TO FABRICATE ANY CONFIGURATION YOU MAY NEED. PLEASE CALL US WITH DETAILS.

CAST IRON COMPANION FLANGE - THREADED



Part #	Size
77-CICFB-08	2"
77-CICFB-09	2 1/2"
77-CICFB-10	3"
77-CICFB-11	4"
77-CICFB-12	5"
77-CICFB-13	6"
77-CICFB-14	8"
77-CICFB-15	10"

STEEL WELDING FLANGE



Part #	Size
03-F083-02-02	2"
03-F083-02-025	2 1/2"
03-F083-02-03	3"
03-F083-02-04	4"
03-F083-02-05	5"
03-F083-02-06	6"
03-F083-02-08	8"
03-F083-02-10	10"
03-F083-02-12	12"

RUBBER FLANGE GASKET

Part #	Size
03-P2347-00	2"
03-F083-82-025	2 1/2"
03-P2347-01	3"
03-P2347-02	4"
03-P2347-03	5"
03-P2347-04	6"
03-P2347-05	8"
03-P2347-06	10"
03-P2347-07	12"

FLANGE x SOCKET (Van Stone Style)

Part #	Size
26-854-020	2"
26-854-030	3"
26-854-040	4"
26-854-060	6"
26-854-080	8"
26-854-100	10"
26-854-120	12"

FLANGE x THREAD (Van Stone Style)

Part #	Size
26-855-020	2"
26-855-030	3"
26-855-040	4"
26-855-060	6"
26-855-080	8"

SPECIFICATIONS FOR TUBING VS. PIPE TERMINOLOGY
 Tubing Measurement is referred to as the I.D. (Inside Dimension)
 Pipe Measurement is referred to as the O.D. (Outside Dimension)
 Please Note: Wall thickness will also aid in determining the correct dimensions required for a project.

90° BLACK SWEEPING ELBOW (14 GAUGE) 

Part #	Size
03-P1097-12	3"
03-P1097-13	4"
03-P1097-15	6"

45° BLACK SWEEPING ELBOW (14 GAUGE) 

Part #	Size
03-P1100-12	3"
03-P1100-13	4"
03-P1100-15	6"

BLACK STEEL TEE (12 GAUGE) 

Part #	Size
22-BSTE4	4"
22-BSTE6	6"
22-BSTE8	8"

END WYE - BLACK (10 GAUGE) - Galvanized Available 

Part #	Size
22-BSY06E	6" End Wye
22-BSY08E	8" End Wye

INLINE WYE - BLACK (10 GAUGE) - Galvanized Available 

Part #	Size
22-BSY06I	6" Inline Wye
22-BSY08I	8" Inline Wye

90° BLACK MITERED ELBOW (10 GAUGE) 

Part #	Size
100-BW900410G	4"
100-BW900610G	6"
100-BW900810G	8"

45° BLACK MITERED ELBOW (10 GAUGE) 

Part #	Size
100-BW450410G	4"
100-BW450610G	6"
100-BW450810G	8"

22.5° BLACK MITERED ELBOW (10 GAUGE) 

Part #	Size
100-BW220410G	4"
100-BW220610G	6"
100-BW220810G	8"

BLACK STEEL HALF NIPPLE 

Part #	Size
03-P2127-10	1"
03-P2127-16	2"
03-P2127-11	2-1/2"
03-P2127-24	3"
03-P2127-29	4"
03-P2127-33	5"
03-P2127-35	6"
03-P2127-37	8"
03-P2127-38	10"

BLACK WELDING CONE (10 GAUGE) 

Part #	Size
03-P0038-80	4" x 2"
03-P3684-01	4" x 3"
03-P3684-02	5" x 4"
03-P3684-03	6" x 4"
03-P3684-04	6" x 5"
03-PS-0015-14G	8" x 4"
03-P3684-05	8" x 6"
03-P3684-06	10" x 8"

BLACK FLAT WELDING DISC 

Part #	Size
03-P1067-02	2"
03-P1067-05	3"
03-P1067-09	4"
03-P1067-11	5"
03-P1067-14	6"
03-P1067-21	8"
03-P1067-25	10"

BLACK STEEL HALF COUPLING 

Part #	Size
03-P2062-06	1"
03-P2062-08	1-1/2"
03-P2062-09	2"
03-P2062-11	3"
03-P2062-12	4"
03-P2062-14	6"

BLACK WELD-ON COUPLER (Galvanized Available) 

Part #	Size
03-P1007-41 (12 Gauge)	2"
03-P1007-42 (12 Gauge)	3"
03-P3875-41 (10 Gauge)	4"
03-P3875-42 (10 Gauge)	5"
03-P3875-43 (10 Gauge)	6"
03-P3875-44 (10 Gauge)	8"
03-P3875-45 (10 Gauge)	10"

GALVANIZED WELD-ON B&L MALE END 

Part #	Size
03-P1050-01	2"
03-P1050-02	3"
03-P1050-03	4"
03-P1050-04	5"
03-P1050-05	6"

BAND & LATCH PARTS

Part #	Size
03-P1030-01	Universal Hook
03-P1012-01	Univ. Catch 2" - 4"
03-P1012-02	Univ. Catch 5" - 8"
03-P1028-01	"U" Clevis
03-P1032-01	E-Z Hook

BLACK WELD-ON MALE END (10 GAUGE) (Galvanized Available) 

Part #	Size
03-P3896-22	4"
03-P3904-01	5"
03-P3904-02	6"
03-P3904-03	8"
03-P3904-04	10"

BLACK ECCENTRIC CONE (12 GAUGE) 

Part #	Size
03-P1734-03	4" x 3"
03-P1734-06	5" x 4"
03-P1735-06	6" x 4"
03-P1736-03	8" x 4"
03-P1735-12	8" x 6"

Part # 100-12VoltPrimerAssembly



wallenstein
vacuum . pumps

Model 30



12v Motor w/ Solenoid

Model 30 Primer Pump

Make hand priming a thing of the past.
Quickly primes the largest centrifugal pump.
Ideal for Irrigation, Industrial and Fire truck service.

Panel Mount Valve with 12v Switch



Specifications

30 CFM @ 15" HG @ 3200 RPM

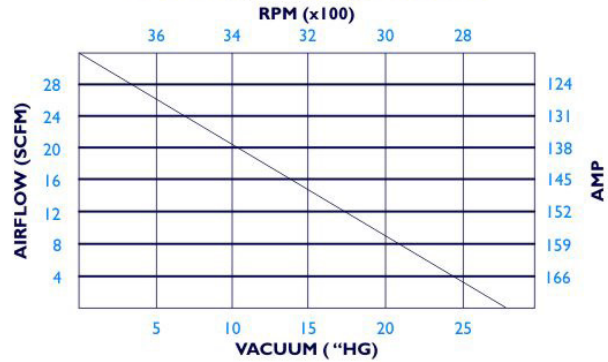

Oil Reservoir 3L with Cap, Mounting Bracket



- Easy Operation
- Easy Installation
- Huge Air Volume
- High Suction Lift

Dimensions

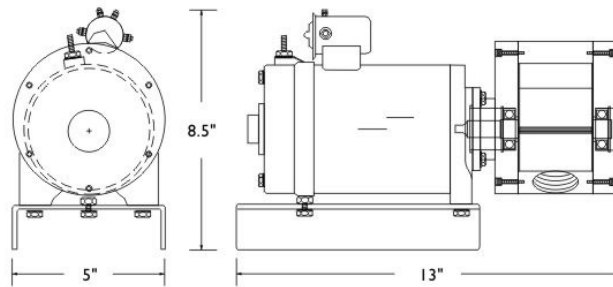

Triple K Irrigation also offers a 110 Volt Power Primer Kit and Portable Power Primer Kit. Please contact us for more details regarding their pricing and availability.



Parts List
30 CFM 12V Primer Pump Kit
Assembly # 0030-005

Item	Description	Qty	Part #
	30HR Primer Pump Head CW		0030-003
101	Expansion plug	1	0030-017
102	Oil seal	2	0030-027
103	Cap screw 1/4 x 1"	12	1000-001
104	Bearing sealed	2	0030-014
105	Retaining ring	2	0030-015
106	Rear endplate	1	0030-013
108	Vane	3	0030-011
110	Taper pin #4	4	1000-419
111	Cap screw 1/4 x 3/8"	4	1000-002
112	Rotor CW	1	0030-009
113	Oil restrictor fitting	1	1001-070
114	Front endplate	1	0030-012
115	Housing with ports	1	0030-006
	Oiler ass'y primer 3 litre		0030-018
301	Oil tank bracket	1	0030-073
302	Gear clamp	2	1001-096
303	Oil reservoir & Cap	1	0030-023
303a	Cap Only	0	0030-045
304	Pick up tube - 13"	1	1000-585
305	Barb fitting	1	1000-068
306	Oil reservoir top	1	0030-026
307	Fitting 90°	1	1000-403
308	Fitting	1	1000-404
309	Oil hose - 18"	1	1000-430
	Panel mount valve & 12v switch		0030-021
500	12V Switch only	1	0030-020
501	Panel mount valve bracket	1	0030-037
502	Panel mount valve 3/4"	1	0030-024
503	Valve mount cap screw	2	0030-036

Item	Description	Qty	Part #
	12V motor assembly with solenoid		0030-010
408	Motor -12 V	1	0030-022
409	12V Solenoid	1	0030-019
410	Ground strap	1	0030-035
411	Cap screw 1/4 x 3/8" NC	2	1000-002
412	Hex nut 5/16" NC	4	FP31HN
413	Motor 12V MTG.stud 5/16 x 1"	4	0030-028
414	Mount bracket (optional)	1	0030-050

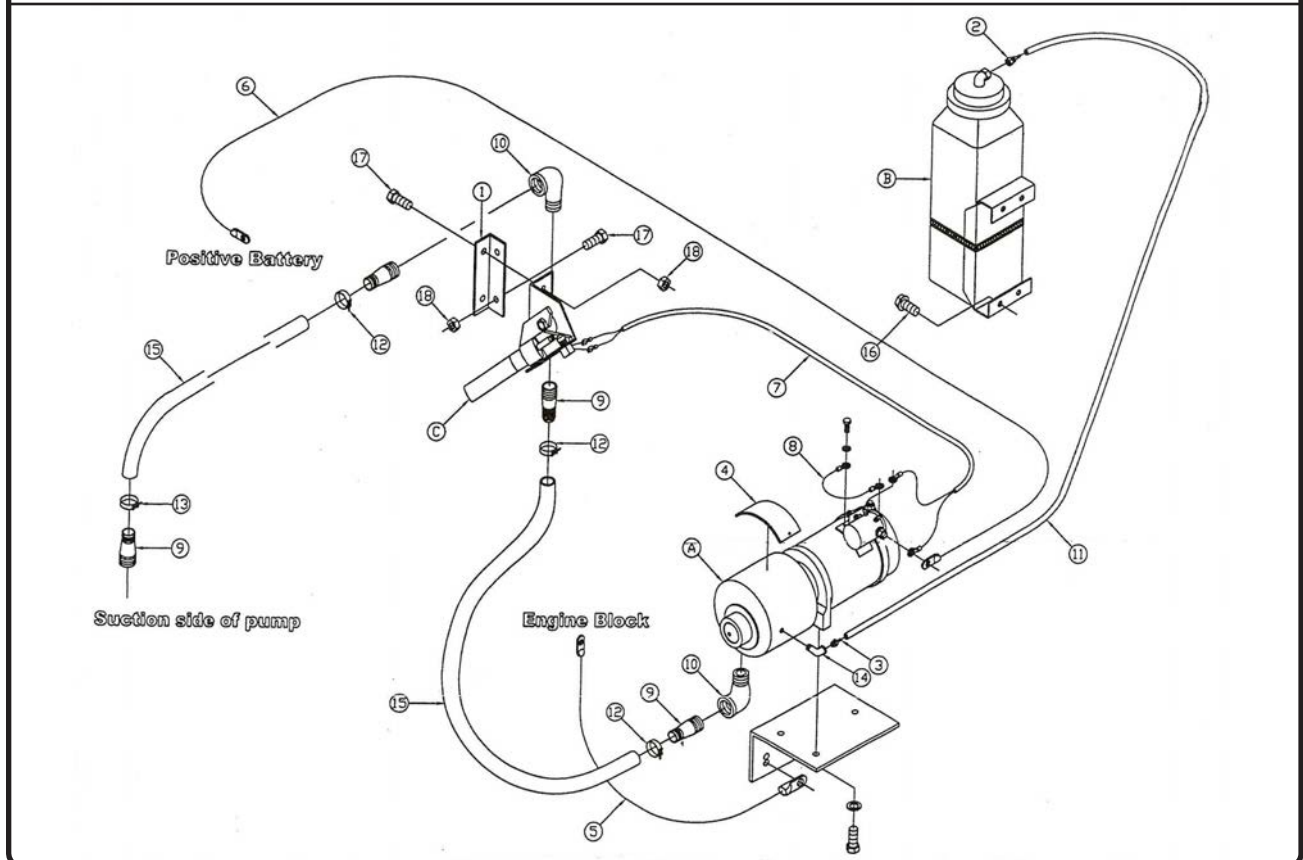

PROTEK DIAPHRAGM PRIMER #5



Part #	Size
07-DP5	#5 Diaphragm Primer

PROTEK DIAPHRAGM PRIMER #7



Part #	Size
07-DP7	#7 Diaphragm Primer

PROTEK DIAPHRAGM PRIMER #9



Part #	Size
07-DP9	#9 Diaphragm Primer

HAND DIAPHRAGM PRIMER - PARTS

LOWER HOUSING FOR DP#5



Part #	Description
07-D0055	Lower Housing for DP#5

LOWER HOUSING FOR DP#7



Part #	Description
07-D0087	Lower Housing for DP#7

LOWER HOUSING FOR DP#9



Part #	Description
07-D0062	Lower Housing for DP#9

UPPER HOUSING FOR DP#5



Part #	Description
07-D0056	Upper Housing for DP#5

UPPER HOUSING FOR DP#7



Part #	Description
07-D0088	Upper Housing for DP#7

UPPER HOUSING FOR DP#9



Part #	Description
07-D0063	Upper Housing for DP#9

DIAPHRAGM FOR DP#5



Part #	Description
07-D0054	Diaphragm for DP#5 (B183)

DIAPHRAGM FOR DP#7



Part #	Description
13-10371465	Diaphragm for DP#7 (C106)

DIAPHRAGM FOR DP#9



Part #	Description
13-10371460	Diaphragm for DP#9 (B61)

DIAPHRAGM PLATE FOR DP#5 (2 Req'd)



Part #	Description
07-D0303	Diaphragm Plate for DP#5

MOUNTING BRACKET FOR DP#7



Part #	Description
07-D0107	Mounting Bracket for DP#7

MOUNTING BRACKET FOR DP#9



Part #	Description
07-D0104	Mounting Bracket for DP#9

CONNECTING ROD ASSEMBLY FOR DP #5, 7 & 9



Part #	Description
07-D0127-A	Connecting Rod Assembly

CHECK VALVE FOR DP #5, 7 & 9



Part #	Description
07-D0004	Check Valve

1-1/2" LOCKNUT FOR DP#9



Part #	Description
07-D0003	1-1/2" Locknut for DP#9

FULCRUM EYEBOLT FOR DP #5, 7 & 9



Part #	Description
07-D0050	Fulcrum Eyebolt for #5 & 7
07-D0051	Fulcrum Eyebolt for #9

HANDLE ASSEMBLY FOR DP #5, 7 & 9



Part #	Description
07-D0047	Handle Assembly-Complete
07-D0093	Handle Bracket Only
07-D0095	Handle w/ Grip Only

CLEVIS PIN ASSEMBLY FOR DP #5, 7 & 9



Part #	Description
07-D0347A	Clevis Pin Assembly

DRAIN VALVE FOR DP #5, 7 & 9



Part #	Description
07-D0340	Drain Valve

BALL CHECK VALVE FOR OLD STYLE DP #5 & 7

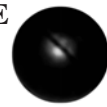

Part #	Description
07-D0339	Ball Check Valve

VALVE BUSHING FOR OLD STYLE DP #5 & 7



Part #	Description
07-D0300	Valve Bushing

BERKELEY AUTOMATIC DISCHARGE PRIMING VALVE

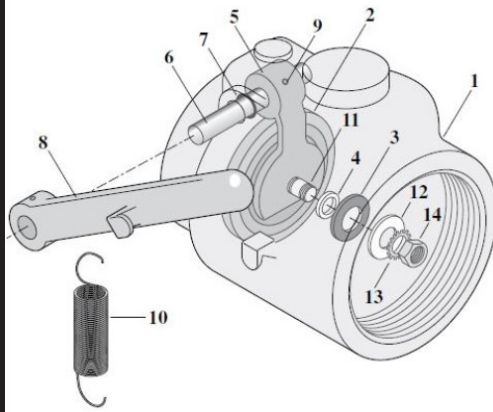

Item #	Part Description	Models			
		3 x 4 w/ Lever	4 x 4 w/ Lever	5 x 5 w/ Lever	6 x 6 w/ Lever
1	Valve Body	24-B05923	24-B05924	24-B05925	24-B05926
2	Clack Rebuild Kit	24-S13414-KIT	24-S13404-KIT	24-S13403-KIT	24-S13393KIT
3	Grommet		(Included in kits)		
4	Spacer, Grommet		(Included in kits)		
5	Clack Hinge,				
6	Shaft and Handle	24-B06142	24-B06143	24-B06144	24-B06145
8	Assembly				
7	O-Ring		(Included in kits)		
9	Pin, Spring (2 Req.)		(Included in kits - 2 of them)		
10	Spring	24-S13679	24-S14026	24-S14026	24-S14026
11	Stud		(Included in kits)		
12	Washer, Flat		(Included in kits)		
13	Washer, External Tooth		(Included in kits)		
14	Nut, Hex		(Included in kits)		

GORMAN-RUPP CHECK VALVE ASSEMBLY

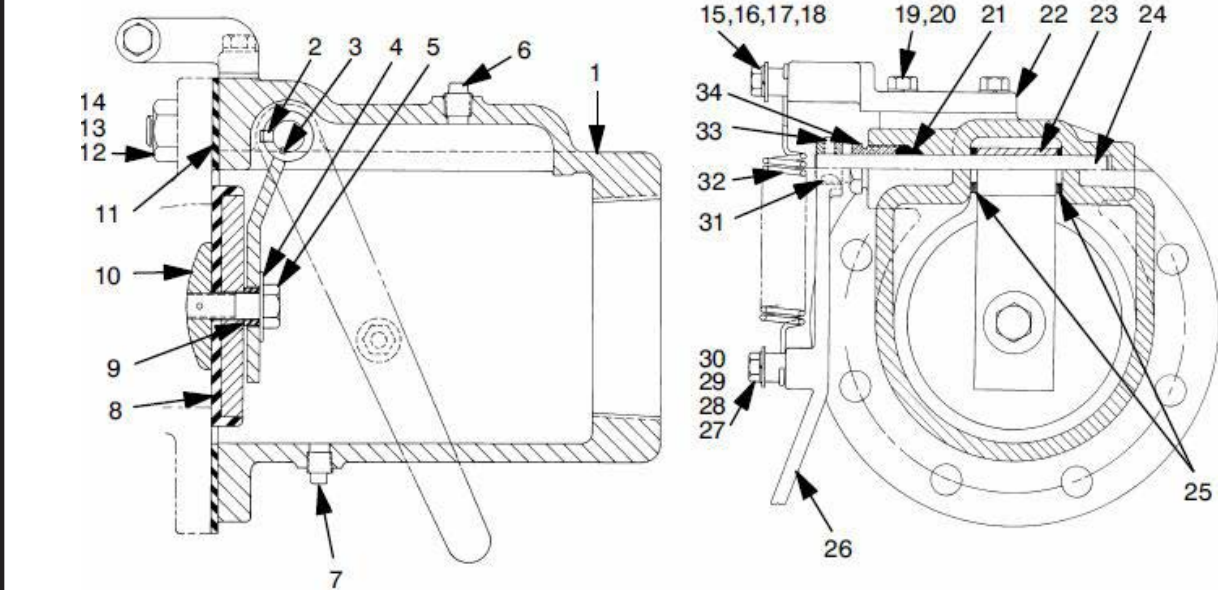

GORMAN-RUPP AUTOMATIC LUBRICATING GREASE CUP

Seal Assembly

The only routine maintenance required on the Gorman-Rupp grease seal is to fill the spring loaded grease cup when required. When the grease cup is empty, turn the cross arm to the bottom of the plunger rod. Remove the grease cup cap by turning it counterclockwise. Fill the grease cup by hand. **DO NOT PRESSURIZE THE GREASE CUP.** Doing so may lubricate stationary parts in the seal causing them to spin and the seal to fail prematurely. After filling the grease cup, replace the cap of the grease cup. Turn the cross arm to the top of the plunger rod. This causes the spring to apply pressure to the grease, forcing the grease into the seal assembly.

It is not uncommon for a new grease seal to drip when using traditional grease prior to the seal faces seating. Remember, this seal uses grease while in use. The grease in the cup may require filling daily when used continuously.

Position When Empty



Position For Filling



Position When In Use



****Replacement parts available for ALL styles of Berkeley, Gorman-Rupp, Caprari and Hale****

CAST IRON COMPANION FLANGE - THREADED 

Part #	Size
77-CICFB-08	2"
77-CICFB-09	2-1/2"
77-CICFB-10	3"
77-CICFB-11	4"
77-CICFB-12	5"
77-CICFB-13	6"
77-CICFB-14	8"

CAST IRON THREADED GATE VALVE with HAND WHEEL 

200 PSI Working Pressure

Part #	Size
77-10RS10	3"
77-10RS11	4"
77-10RS12	5"
77-10RS13	6"

CAST IRON FLANGED GATE VALVE with OP NUT 

200 PSI Working Pressure

Part #	Size
77-200W11NW	4"
77-10RW12N	5"
77-200W13NW	6"
77-200W14NW	8"

CAST IRON FLANGED GATE VALVE with HAND WHEEL 

200 PSI Working Pressure

Part #	Size
77-200W11W	4"
77-10RW12	5"
77-200W13W	6"
77-200W14W	8"

STEEL WELDING FLANGE 

Part	Size
03-F083-02-02	2"
03-F083-02-025	2-1/2"
03-F083-02-03	3"
03-F083-02-04	4"
03-F083-02-05	5"
03-F083-02-06	6"
03-F083-02-08	8"
03-F083-02-10	10"
03-F083-02-12	12"

RUBBER FLANGE GASKET 

Part #	Size
03-P2347-00	2"
03-F083-82-025	2-1/2"
03-P2347-01	3"
03-P2347-02	4"
03-P2347-03	5"
03-P2347-04	6"
03-P2347-05	8"
03-P2347-06	10"
03-P2347-07	12"

HANDLE FOR CI GATE VALVE 

Part #	Size & Description
77-EMKL36	36" T-Wrench for 2" Op Nut
77-EMKL60	60" T-Wrench for 2" Op Nut

4-BOLT FLANGED MZ SLIDE VALVE 

Part #	Size
72-450400825	4"
72-450400827	6"
72-450400828	8"

NPT x NPT BRASS MZ SLIDE VALVE 

Part #	Size
72-450490140	4"
72-450490142	6"

CAST IRON WAFER STYLE BUTTERFLY Valve
Ductile Disc/Buna Seat/SS Stem - Irrigation Application
(Lug Style Available) 

Valve Size	Part# Gear Operated	Part# Lever Operated
2"	77-B6-RWG2	77-B6-RLO2
3"	77-B6-RWG3	77-B6-RLO3
4"	77-B6-RWG4	77-B6-RLO4
6"	77-B6-RWG6	77-B6-RLO6
8"	77-B6-RWG8	77-B6-RLO8

NOTE: For chemical & manure fluent, a B5 Series valve may be required. The B5 Series is also required for underground applications. Please call if you have any questions regarding these valves.

AIR CYLINDER FOR MZ VALVE (Double Acting) 

Part #	Size
72-450401821	4"
72-450401823	6"
72-450401824	8"

HYDRAULIC CYLINDER FOR MZ VALVE (Double Acting) 

Part #	Size
72-450490044	4"-6"
72-450490049	8"

BUTTERFLY VALVE EXTENSION (for B5 Series Valve Only)

Part #	Size & Description
77-B5-X48-C	48" Extension for 5"- 6" B5 BFV
77-B5-X48-D	48" Extension for 8" B5 BFV

STEEL FLANGE FOR MZ VALVE 

Part #	Size
100-2005-0000	4"
100-2006-0000	6"
100-2006-0001	8"

MANUAL HANDLE FOR MZ VALVE 

Part #	Size
100-450200750	4"
100-450200752	6"
100-450200753	8"

BUTTERFLY VALVE DISC 

Part #	Size
03-P1164-01	4"
03-P1166-01	6"
03-P1167-01	8"

GASKET FOR MZ VALVE 

Part #	Size
72-450200588	6"
72-370200100	8"

THREADED BRASS GATE VALVE



Features:

200# (150 degrees F) non-shock. Solid disc, non-rising stem, solder ends.

Part #	Size
77-514T03	1/2"
77-514T04	3/4"
77-514T05	1"
77-514T08	2"
77-514T10	3"
77-514T11	4"

THREADED BRASS BALL VALVE



Features:

Working pressure 600# PSI WOG. PTFE reinforced seats and seals. "K-Metal" non-corrosive stem. Full port, full flow capacity.

Part #	Size
77-759T03	1/2"
77-759T04	3/4"
77-759T05	1"
77-759T08	2"
77-759T10	3"
77-759T11	4"

SLIP PVC BALL VALVE



Features:

Economical valve of durable, high quality PVC material for long life. No adjustment necessary.

Part #	Size
77-770S03N	1/2"
77-770S04N	3/4"
77-770S05N	1"
77-770S06N	1 1/4"
77-770S07N	1 1/2"
77-770S08N	2"

THREADED PVC BALL VALVE



Features:

Economical valve of durable, high quality PVC material for long life. No adjustment necessary.

Part #	Size
77-770T03N	1/2"
77-770T04N	3/4"
77-770T05N	1"
77-770T06N	1 1/4"
77-770T07N	1 1/2"
77-770T08N	2"

INDEPENDENT MAIN TO LATERAL VALVE

Allows supply to lateral lines from mainline by installing at location desired. Includes roundback gasket.



Part #	B&L		Ringlock Valve Stub
	Male End	Bell	
03-P1072-62	4"	4"	3"
03-P1073-61	4"	4"	4"
03-P1073-63	6"	6"	4"

Part #	Ringlock		
	Male End	Ringlock Bell	Ringlock Valve Stub
03-P1767-63	6"	6"	4"



VALVE OPENING ELBOW



Part #	Size
03-P1694-61	3" x 2"
03-P1694-62	3" x 3"
03-P1694-64	4" x 3"
03-P0009-04	4" x 4"
03-P0004-52	6" x 4"
03-P0034-88	6" x 6"

VALVE OPENING TEE



Part #	Size
03-P1711-64	4" x 3" x 3"
03-P1711-65	4" x 4" x 4"
03-P1711-72	6" x 4" x 4"
03-P1711-74	6" x 6" x 6"

RISER VALVE W/ FEMALE PIPE THREAD



Part #	Size
03-P1726-01	3"
03-P1726-02	4"
03-P1726-04	6"
03-P1726-05	8"

WELD-ON RISER VALVE FELCO-ALUMINUM



Part #	Size
16-UVS404	4" x 4"
16-UVS406	4" x 6"
16-UVS408	4" x 8"

VALVE STUB WITH MALE THREAD



Part #	Size
03-P1729-01	3"
03-P1729-02	4"
03-P1729-04	6"
03-P1729-05	8"

WELD-ON VALVE STUB - RINGLOCK



Part #	Size
03-P1724-01	3"
03-P1724-02	4"
03-P1724-04	6"
03-P1724-05	8"

INLINE BUTTERFLY VALVE - BAND & LATCH



Part #	Size
03-P1812-61	4"
03-P1814-61	6"
03-P1815-61	8"

INLINE BUTTERFLY VALVE - RINGLOCK



Part #	Size
03-P1821-61	4"
03-P1823-61	6"
03-P1824-61	8"

VALVE OPENER PARTS DIAGRAM

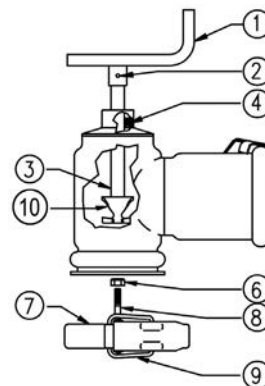

VALVE STUB DISC



Part #	Size
03-P1059-01	3"
13-100851	4"
03-P1061-01	5"
03-P1062-01	6"
03-P1063-01	8"

VALVE STUB STEM

Part #	Valve Size
03-P2086-01	3" or 4"
03-P2086-02	5" or 6"
03-P2114-01	8"

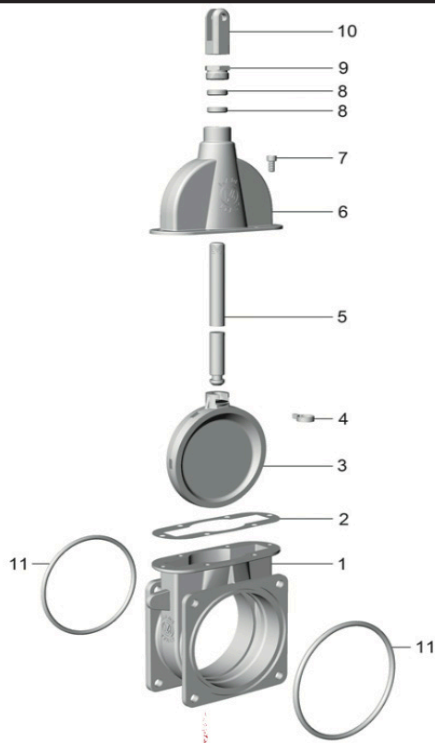

4-BOLT FLANGED MZ SLIDE VALVE PARTS

Item #	Part Description	Size	Part #
2	Gasket	4"	450401696
2	Gasket	6"	450401698
2	Gasket	8"	450401699
3	Gate	4"	450401708
3	Gate	6"	450401710
3	Gate	8"	450401711
4	Locking Clamp	4" & 6"	450401719
4	Locking Clamp	8"	450GG0M00
5	Stem	4"	450401688
5	Stem	6"	450401690
5	Stem	8"	450401691
6	Upper Housing	4"	450401704
6	Upper Housing	6"	450401706
6	Upper Housing	8"	450401707
7	Screw TCEI M8x16	4" - 8"	450401683
8	Packing Ring	4" & 6"	450401681
8	Packing Ring	8"	450401682
9	Nut M30x2	4" & 6"	450401727
9	Nut M35x2	8"	450401680
10	Fork/Yoke	4" - 8"	450401678
11	O-Ring 225	4" & 6"	450401716
11	O-Ring 240	8"	450401717

CAST VALVE WITH STAINLESS STEEL KNIFE PARTS

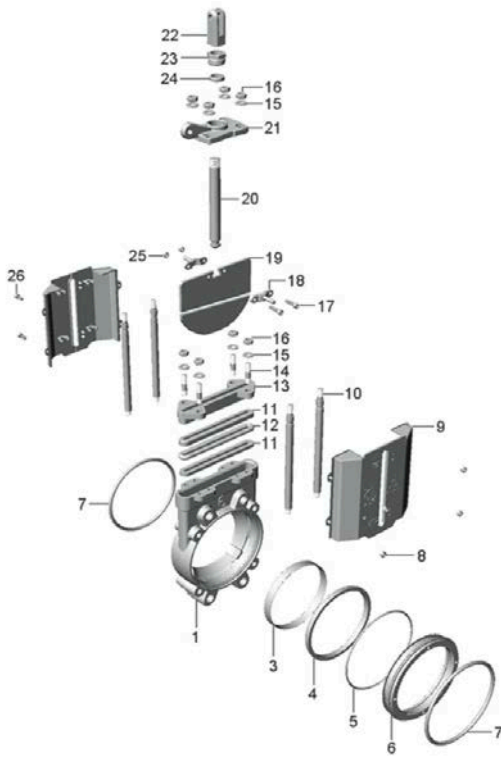

Item #	Part Description	Size	Part #
2	Seat Ring	6"	450080015
2	Seat Ring	8"	450080016
3	Blocking Ring	6"	450090007
4	Estate Ring	6"	450090004
6	Sleeve	6"	450150008
6	Sleeve	8"	450150009
6	Sleeve	10"	450150011
6	Sleeve	12"	450150012
7	O-Ring 206	4"	450401721
7	O-Ring 225	6"	450401716
7	O-Ring 241	8"	450401700
7	O-Ring 249	10"	450401697
7	O-Ring	12"	450401720
8	Locking Nut	4" - 12"	450401907
10	Stem	6"	450401893
10	Stem	8"	450401892
11	Braided Ring	6"	450401895
11	Braided Ring	8"	450401896
12	O-Ring Packing	6"	450401897
12	O-Ring Packing	8"	450401898
13	Packing Flange	6"	450401899
13	Packing Flange	8"	450401900
14	Stud	4" - 12"	450401894
15	Washer	4" - 12"	450450083
16	Nut	4" - 12"	450450084
18	Indicator Clamp	6"	450401902
18	Indicator Clamp	8"	450401903
18	Indicator Clamp	10"	450401904
18	Indicator Clamp	12"	450401905
19	Knife	6"	450401908
19	Knife	8"	450401901
26	Screw	6" - 12"	450401906

BRASS SIDE LEVER GATE VALVE PARTS



Item #	Part Description	Size	Part #
2	Screw M6x12	2", 2-1/2"	450401751
2	Screw M8x16	3", 4", 6"	450401749
3	Handle	3", 2-1/2"	449013402
3	Handle	3"	449013403
3	Handle	4"	449013405
3	Handle	6"	449014405
4	Nut 3/4"	2", 2-1/2"	450401756
4	Nut M30x2	3"	450401727
4	Nut F19	4" - 6"	450401679
5	Packing Ring	2", 2-1/2"	450401755
5	Packing Ring	3"	450401681
5	Packing Ring	4" - 6"	450401682
6	Pin	2"	450401757
6	Pin	3"	450401728
6	Pin	4"	450401729
6	Pin	6"	450401730
7A	Male Disk	2"	450401758
7B	Female Disk	2"	450401759
7A	Male Disk	3"	450401731
7B	Female Disk	3"	450401732
7A	Male Disk	4"	450401733
7B	Female Disk	4"	450401744
7A	Male Disk	6"	450401735
7B	Female Disk	6"	450401737
8	Inner Lever	2"	450401760
8	Inner Lever	3"	450401738
8	Inner Lever	4"	450401739
8	Inner Level	6"	450401741
9	Paper Gasket	2"	450401764
9	Paper Gasket	3"	450401740
9	Paper Gasket	4"	450401742
9	Paper Gasket	6"	450401744
10	Head	2"	450401765
10	Head	3"	450401745
10	Head	4"	450401747
10	Head	6"	450401748
11	Screw M6x12	2"	450401750
11	Screw M8x16	3", 4", 6"	450401683

BRASS PISTON VALVE WITH SS KNIFE

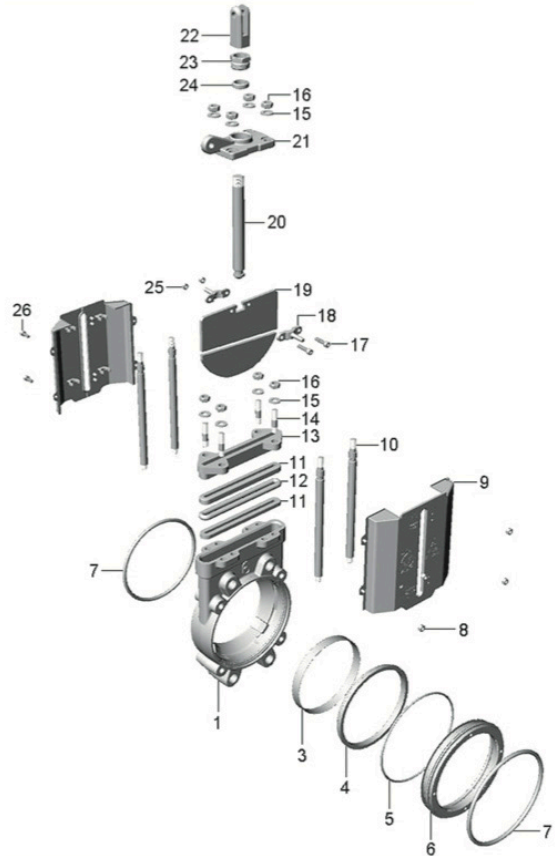

Item #	Part Description	Size	Part #
1	Lower Housing	6"	GLMANUREWHSL
2	White Seat Ring	6"	450080015
2	White Seat Ring	8"	450080016
3	4587 O-Ring	6"	450020125
5	Sleeve	6"	450080011
6	232 O-Ring	6"	45008015
6	244 O-Ring	8"	450401701
7	Knife	6"	450450080
7	Knife	8"	450450079
8	Clip	6"	450450087
8	Clip	8"	450450088
9	Screw	6"	450450089
9	Screw	8"	450450090
10	Gasket	6"	450450077
10	Gasket	8"	450450078
12	Head	6"	450450075
12	Head	8"	450450076
11	Screw M8x16	3", 4", 6"	450401683
17	Self-Locking Nut	4" & 6"	450450085
17	Self-Locking Nut	8"	450450086

GALV MPT x BALL w/ LOCKING LEVER



Part	Size
112-020-BMT2	2"
112-020-BMT3	3"
112-020-BMT4	4"
112-020-BMT6	6"
112-020-BMT8	8"

GALV MPT x SOCKET



Part #	Size
112-040-SMT2	2"
112-040-SMT3	3"
112-040-SMT4	4"
112-040-SMT6	6"
112-040-SMT8	8"

GALV FPT x BALL w/ LOCKING LEVER



Part	Size
112-025-BFTA2	2"
112-025-BFTA3	3"
112-025-BFTA4	4"
112-025-BFTA6	6"
112-025-BFTA8	8"

GALV FPT x SOCKET



Part #	Size
112-045-SFTA2	2"
112-045-SFTA3	3"
112-045-SFTA4	4"
112-045-SFTA6	6"
112-045-SFTA8	8"

BAUER TYPE "B-STYLE" O-RING



Part	Size
109-436-20	2"
109-436-30	3"
109-436-40	4"
109-436-50	5"
109-436-60	6"
109-436-80	8"

BLACK STEEL WELD-ON MALE BALL



Part #	Size
112-255-B2B	2"
112-255-B3B	3"
112-255-B4B	4"
112-255-B6B	6"
112-255-B8B	8"

BLACK STEEL WELD-ON FEMALE SOCKET



Part	Size
112-257-S2B	2"
112-257-S3B	3"
112-257-S4B	4"
112-257-S6B	6"
112-257-S8B	8"

LOCKING LEVER



Part #	Size
112-273-LR2	2"
112-273-LR3	3"
112-273-LR4	4"
112-273-LR6	6"
112-273-LR8	8"

GALV MALE BALL x HOSE BARB



Part	Size
112-260-HTM2	2"
112-260-HTM3	3"
112-260-HTM4	4"
112-260-HTM6	6"
112-260-HTM8	8"

GALV FEMALE SOCKET x HOSE BARB



Part #	Size
112-270-HTF2	2"
112-270-HTF3	3"
112-270-HTF4	4"
112-270-HTF6	6"
112-270-HTF8	8"

ALUMINUM MALE WELD-ON BALL



Part	Size
112-732-BA2	2"
112-732-BA3	3"
112-732-BA4	4"
112-732-BA6	6"
112-732-BA8	8"

ALUMINUM FEMALE WELD-ON SOCKET



Part #	Size
112-734-AA2	2"
112-734-AA3	3"
112-734-AA4	4"
112-734-AA6	6"
112-734-AA8	8"

GALV 30° ELBOW



Part	Size
112-085-E2-30	2"
112-085-E3-30	3"
112-085-E4-30	4"
112-085-E6-30	6"
112-085-E8-30	8"

GALV 45° ELBOW



Part #	Size
112-080-E2-45	2"
112-080-E3-45	3"
112-080-E4-45	4"
112-080-E6-45	6"
112-080-E8-45	8"

GALV 60° ELBOW



Part	Size
112-075-E2-60	2"
112-075-E3-60	3"
112-075-E4-60	4"
112-075-E6-60	6"
112-075-E8-60	8"

GALV 90° ELBOW



Part #	Size
112-070-E2-90	2"
112-070-E3-90	3"
112-070-E4-90	4"
112-070-E6-90	6"
112-070-E8-90	8"

Please note there are two styles of Bauer Type connections. Please specify your type:
 Type A = Clamp fastened on coupling OR Type B = Clamp loose
Additional styles and sizes are available upon request.

“A-STYLE” GALV FEMALE SOCKET w/ LEVER x HOSE BARB



Part	Size
72-450220760	8"
72-450220100	10"
72-450220101	12"

“A-STYLE” GALV MALE RING X HOSE BARB



Part	Size
72-450220761	8"
72-450220111	10"
72-450220112	12"

“A-STYLE” BLACK WELD-ON MALE BALL



Part	Size
72-450220556	8"
72-452101010	10"
72-452121212	12"

“A-STYLE” BLACK LOCKING RING



Part	Size
72-450220555	8"
72-452111222	10"
72-452111333	12"

“A-STYLE” BLACK WELD-ON FEMALE w/ LEVER w/ O-RING



Part	Size
72-450220561	8"
72-452000777	10"
72-452000888	12"

“A-STYLE” BAUER TYPE COUPLINGS

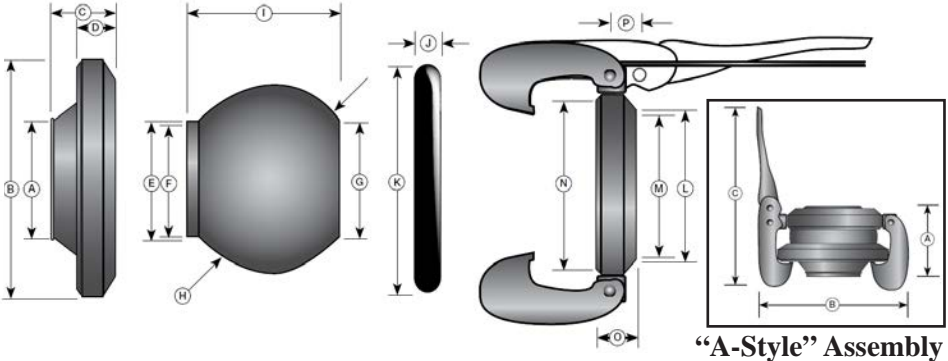

“A-Style” Assembly

“A-STYLE” O-RING



Part	Size
72-450220568	8"
72-452452250	10"
72-452452251	12"

“B-STYLE” BAUER TYPE COUPLINGS

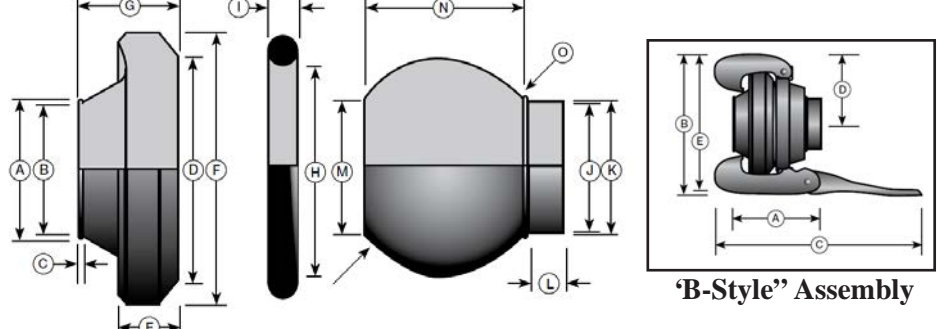

“B-Style” Assembly

“F-STYLE” WELD-ON FEMALE W/ LEVER W/ O-RING



Part	Size
72-452205601	6"

“F-STYLE” GALV FEMALE SOCKET WITH LEVER x HOSE BARB



Part #	Size
72-450220583	6"

“F-STYLE” HOSE BARB x MALE BALL



Part #	Size
72-450220575	6" (150mm)

BLACK MALE LOCKING RING “F-STYLE”



Part	Size
72-450220792	6"

DODA 3-HOOK COUPLER w/ O-RING



Part #	Size
97-FER111	6" Black

“F-STYLE” WELD-ON MALE BALL



Part	Size
72-452205551	6"

DODA O-RING



Part #	Size
97-GTP138	6" (150mm)

IRONSIDE
HIGH PRESSURE HEAVY DUTY DISCHARGE HOSE

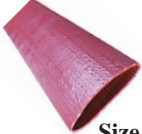

Part #	Size	PSI
45-IS150x300	1-1/2"	150
45-IS200x300	2"	150
45-IS300x300	3"	150
45-IS400x300	4"	125
45-IS600x300	6"	115
45-IS800x300	8"	70

VINYLFLOW
LOW PRESSURE DRIP & WATER DISCHARGE HOSE

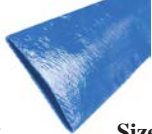

Part #	Size	PSI
45-VF150x300	1-1/2"	80
45-VF200x300	2"	80
45-VF300x300	3"	70
45-VF400x300	4"	70
45-VF600x300	6"	50
45-VF800x300	8"	45

TIGERFLEX
HEAVY DUTY PVC FABRIC REINFORCED WITH HIGH UV RESISTANCE



Part #	Size
45-WST-SLR200X100	2"
45-WST-SLR300X100	3"
45-WST-SLR400X100	4"
45-WST-SLR600X100	6"

TIGERFLEX
CLEAR HEAVY DUTY SUCTION HOSE SYNTHETIC REINFORCEMENT (WORKING PRESSURE 45 PSI @ 68')



Part #	Size
45-WST300x300	3"
45-WST400x300	4"
45-WST500x300	5"
45-WST600x300	6"
45-WST800x300	8"

POLYAIR SERIES
MULTI-PURPOSE AIR & WATER HOSE



Part #	Size	PSI
45-K1134-08	1/2"	300
45-K1134-12	3/4"	250
45-K1134-16	1"	250

TIGERFLEX
YELLOW EPDM DISCHARGE & SUCTION HOSE (WORKING PRESSURE 65 PSI @ 68')



Part #	Size
45-TY150x100	1-1/2"
45-TY200x100	2"
45-TY300x100	3"

TIGERFLEX
BLACK EPDM DISCHARGE & SUCTION HOSE (WORKING PRESSURE 100 PSI @ 68')



Part #	Size
45-TSD200x100	2"
45-TSD300x100	3"

150 PSI EPDM
MULTI-PURPOSE WATER DISCHARGE/SUCTION HOSE



Part #	Size
45-T202AA200	2"
45-T202AA300	3"
45-T202AA400	4"
45-T202AA600	6"
45-T202AA800	8"

NOTE: We have the ability to cut short lengths of the mainline, discharge and suction hoses, if needed.

ALL-AMERICAN / SNAP-TITE (SERIES 110) TRAVELER HOSE
(URETHANE CONSTRUCTION)



Part #	Size
79-IR40X660B	4"
79-IR45X660B	4-1/2"

ANGUS PREMIUM TRAVELER HOSE
(THIN RIB YELLOW)



Part #	Size
64-340050	4"
64-345050	4-1/2"

GATORFLOW
NITRILE / PVC RESISTANT RUBBER DISCHARGE HOSE



Part #	Size
45-GF200x200	2"
45-GF300x200	3"
45-GF400x200	4"
45-GF600x100	6"
45-GF800x100	8"

TIGERFLEX
TIGER GREEN TG SERIES EPDM SUCTION HOSE



Part #	Size
45-TG250X100	2 1/2"

TIGERFLEX W SERIES
HEAVY DUTY PVC LIQUID SUCTION HOSE



Part #	Size
45-W250X100	2 1/2"
45-W300X100	3"
45-W400X100	4"
45-W600X100	6"

OROFLEX20 MAINLINE HOSE

OROFLEX
LAYFLAT HOSES

Part #	Size
123-Oroflex20 6"	6"
123-Oroflex20 7"	7"
123-Oroflex20 8"	8"
123-Oroflex20 10"	10"

OROFLEX30 DRAG HOSE

OROFLEX

Part #	Size
123-Oroflex30 4"	4"
123-Oroflex30 5"	5"
123-Oroflex30 6"	6"

See
Page 19
For
Clamps



**MANDALS
SUPERMAN
MAINLINE
LENGTH: 660'**

mandals



Part #	Size
43-ULY203SM200	8"
43-ULY254SM200	10"
43-ULY305SM200	12"

**MANDALS
DRAGMAN
DRAG HOSE
mandals**



Part #	Size	Length
43-DRX127OM200	5"	660'
43-DRX127OM300	5"	990'
43-DRX127OM400	5"	1320'
43-DRX140OM200	5.5"	660'
43-DRX140OM300	5.5"	990'
43-DRX140OM400	5.5"	1320'
43-DRX152OM200	6"	660'
43-DRX152OM300	6"	990'
43-DRX152OM400	6"	1320'
43-DRX178OM200	7"	660'

**MANTEX HOSE
ASSEMBLY WITH
DIXON ENDS**



Part #	Size
100-2x50MANTEXHOSE	2" x 50'
100-3x50MANTEXHOSE	3" x 50'

**MANTEX AIR HOSE
LESS ENDS**

Part #	Size
43-HPY051OM	2" x 50'
43-HPY076OM998	3" x 50'

**DIXON AIR
HOSE CONNECTION**

Part #	Description
154-GB28	2" WNT x Female NPT
154-GB38	3" WNT x Female NPT
154-GM28	2" Male NPT x WNT
154-GM38	3" Male NPT x WNT
154-GDB28	2" WNT x WNT
154-GDB38	3" WNT x WNT

Single Bolt Supra / Super Clamp



Part #	Inches Diameter	MM Diameter
72-4650.03	29/32" - 63/64"	23 - 25
72-4650.04	1 5/32" - 1 7/32"	26 - 28
72-4650.06	1 5/16" - 1 7/16"	34 - 37
72-4650.07	1 7/16" - 1 9/16"	37 - 40
72-4650.08	1 9/16" - 1 11/16"	40 - 43
72-4650.09	1 11/16" - 1 7/8"	43 - 47
72-4650.10	1 7/8" - 2"	47 - 51
72-4650.11	2" - 2 5/32"	51 - 55
72-4650.12	2 5/32" - 2 5/16"	55 - 59
72-4650.13	2 5/16" - 2 1/2"	59 - 63
72-4650.14	2 1/2" - 2 11/16"	63 - 68
72-4650.15	2 11/16" - 2 7/8"	68 - 73
72-4650.16	2 7/8" - 3 1/8"	73 - 79
72-4650.17	3 1/8" - 3 11/32"	79 - 85
72-4650.18	3 11/32" - 3 9/16"	85 - 91
72-4650.19	3 9/16" - 3 13/16"	91 - 97
72-4650.20	3 13/16" - 4 3/32"	97 - 104
72-4650.21	4 3/32" - 4 3/8"	104 - 112
72-4650.22	4 3/8" - 4 3/4"	112 - 121
72-4650.23	4 3/4" - 5 1/8"	121 - 130
72-4650.24	5 5/32" - 5 1/2"	130 - 140
72-4650.25	5 1/2" - 5 7/8"	140 - 150
72-4650.26	5 7/8" - 6 3/8"	150 - 162
72-4650.27	6 3/8" - 6 7/8"	162 - 174
72-4650.28	6 7/8" - 7 3/8"	174 - 187
72-4650.29	7 3/8" - 7 15/16"	187 - 200
72-4650.30	7 15/16" - 8 7/16"	200 - 213
72-4650.31	8 7/16" - 8 15/16"	213 - 226
72-4650.34	10" - 10-1/2"	254 - 267

Spiral Double Bolt Clamp

(COUNTER CLOCKWISE/ LEFT HANDED)



Part #	Size
45-SDBC2	2"
45-SDBC3	3"
45-SDBC4	4"
45-SDBC6	6"
45-SDBC8	8"
45-SDBC10	10"

Band-It® Center Punch Clamp



Part #	Size
23-CP12S9	3" x 5/8"
23-CP16S9	4" x 5/8"
23-CP24S9	6" x 5/8"
23-CP32S9	8" x 5/8"

Worm Gear Clamp



Part #	Size
63-H1000P	9/16" - 1 1/16"
63-H1200P	11/16" - 1 1/4"
63-H1600P	3/4" - 1 1/2"

Center Punch Tool



Part #	Size
60-HBC300	5/8" Punch tool

Travis Ringlock Clamp



Part #	Size
16-HPRLC300	3"
16-HPRLC400	4"
16-HPRLC500	5"
16-HPRLC600	6"
16-HPRLC600TL	6"(oversize)
16-HPRLC800	8"
16-HPRLC800TL	8"(oversize)

Victaulic Grooved Clamp



Part #	Size
03-F087-90-08G	2"
03-F087-90-10G	2.5"
03-F087-90-12G	3"
03-F087-90-16G	4"
03-F087-90-20G	5"
03-F087-90-24G	6"
03-F087-90-32G	8"

Felton Ringlock Clamp



Part	Size
16-1864-1	6"
16-1865-1	8"

Shug Grip Coupler HD Ring Clamp



Part	Size
20-M3CL6	6"
20-M3CL8	8"
20-M3CL10	10"

Shug Grip Coupler Single-Wide 3-Piece Clamp



Part	Size
100-3P4	4"

Double Bolt Hose Clamp



Part #	Size Range
45-DB463	4 1/16" - 4 5/8"
45-DB525	4 11/16" - 5 1/4"
45-DB550	5" - 5 1/2"
45-DB600	5 1/16" - 6 1/16"
45-DB675	6 1/8" - 6 7/8"
45-DB769	6 15/16" - 7 5/8"
45-DB818	7 11/16" - 8 3/16"
45-DB875	8 1/4" - 8 7/8"
45-DB988	8 15/16" - 9 7/8"

Pierce Ringlock Clamp



Part #	Size
03-P2123-08	4"
03-P2123-01	5"
03-P2123-02	6"
03-P2123-03	8"
03-P2123-04	10"
03-P2123-05	12"

Band & Latch Assembly



Part #	Size
03-P1034-01	2"
03-P1035-01	3"
03-P1036-81	4"
03-P1036-82	5"
03-P1036-83	6"
03-P1037-82	8"

Shug Grip Coupler Double-Wide 3-Piece Clamp



Part #	Size
20-M3SEG45-3A	4.5"
20-M3SEG5-3A	5"
20-M3SEG55-3A	5.5"
20-M3SEG6-3A	6"
20-M3SEG7-4A	7"
20-M3SEG8-4A	8"
20-M3SEG10-5A	10"



CADMAN LARGE TRAVELERS

Cadman is the leader for large travelers. Their design is based on the company’s motto:

Strength...Simplicity...Dependability

The frame is by far the strongest in the industry. By utilizing high quality tubing for the upper and lower frames and a continuous core for the drum, Cadman is unmatched for strength.

The Cadman drive system is the simplest to use in the industry. The speed-compensation system is very accurate and user friendly. For dependability, the Cadman traveler is on top. Because they keep the end user in mind, the Cadman traveler is built with the highest quality components, including the Honda engine, heavy duty transmission, high tensile chain, and the best turn-table available. You can always count on a Cadman traveler to be ready to go to the field.

Compared to the competition’s multiple rods and levers, Cadman only has one lever on the transmission and one knob to control the speed.



Model	Hose I.D.	Hose Length	Flow Rate GPM
3600XL-B	3.6"	2250'	220 - 297
3750XL Wide Body	3.75"	1320'	320 - 425
4000S Wide Body	4.04"	1250'	400 - 530
4000XL Wide Body	4.0"	1400'	369 - 500
4000XL Wide Body	4.0"	1550'	349 - 472
4000XL Wide Body	4.0"	1850'	317 - 429
4500 Wide Body	4.5"	1320'	519 - 702
5000 Wide Body	5.0"	1200'	719 - 973

CADMAN JOHN DEERE POWER PAK



Cadman builds a unit packed with features and benefits that allows the engine to perform at maximum performance. Advanced engine controls constantly monitor engine load and ambient conditions. A 125° ambient temperature radiator, with a variable-pitch fan for maximum performance, two-stage air cleaner, and a 700 cold cranking amp battery are standard. Following guidelines of the engine manufacturer, Cadman mounts the engine and performs vibration analysis, so that you, the customer have an end product that provides smooth, trouble-free service.

CADMAN MINI-POWER UNIT

Portable High-Pressure Engine-Driven Pump
 Caprari Pump with Honda Engine
 100-350 GPM at 40-120 PSI / Range is 13-22 HP



CADMAN 6003 HOSE CADDY

Holds up to three 6" x 660' supply hoses!
 09-TR-CAD-HC3PT-3



CAPRARI PTO PUMPS - Rugged Tractor Driven Centrifugal Pumps

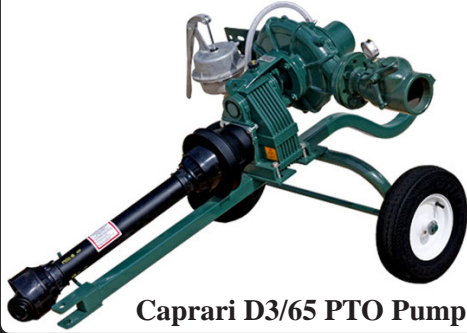

Caprari D3/65 PTO Pump

Caprari PTO Pumps have a heavy duty trailer with 4.00 x 8 standard tires. The pumps are supplied with a PTO shaft, hand primer and discharge check valve. An appropriately sized NPT female coupling is supplied for the suction end.

Models Available:
 Flow Range from 50 -1400 GPM
 PSI Range from 21 -200 PSI
 RPM Range from 540



SAE MOUNT WATER PUMPS

Caprari pumps are known worldwide for their quality construction, reliability, and high efficiency.

The two and three-stage horizontal shaft centrifugal pumps are equipped with oversized supports and bearings to provide superior coupling dependability for connection to a gasoline or diesel engine. All pumps are flanged for SAE 3 engines, however, adapter rings are available for SAE 1, 2 and 4 engines. Pumps are composed of a suction cover, flow directing bladed diffusers, volute shaped casing, bearing housing, grey cast iron impellers, stainless steel shaft and external carbon steel tie bolts to securely fasten the pump assembly.



HONDA WATER PUMP

3" NorthStar High Pressure Water Pump with 3" Ports
 10,500 GPH
 116 PSI
 270 CC Honda GX270 Engine



**SAE ENGINE-MOUNT TYPE B CENTRIFUGAL PUMPS
 or FRAME-MOUNT TYPE B CENTRIFUGAL PUMPS**

For more than half a century now, distinctive-orange Berkeley pumps have earned a worldwide reputation for rugged construction and dependable performance in the most demanding installations. Berkeley pumps can be found in building services, firefighting, dewatering, irrigation, process liquid transfer, municipal water supply and many other applications. Electric pumps also available.



CORNELL MANURE SLURRY PUMP

Cornell has incorporated many unique and innovative design features into its liquid waste slurry pumps, while maintaining its position in the industry as the leader of heavy-duty, low maintenance pumps. Cornell's liquid waste slurry pumps have been used successfully in a variety of farm, industrial and municipal waste applications. Their slurry and non-clog pumps are used in big gun applications, injection systems and liquid manure transfer. These pumps are designed specifically to handle manure slurry applications and provide a long service life.



DODA LIQUID MANURE PTO PUMP

The Doda Manure Pump has a number of features that make it a cut above the rest.

- Tough gearbox capable of handling the higher hp requirements of the larger gallonages & pressures.
- High pressure capability to help push that extra volume and distance.
- Static cutter knives to chop up any solids that find their way into the pump.
- Mechanical seal with a secondary lubrication and located separate from the gear case which prevents gearbox failure due to seal failure.
- Quick connect suction fittings are standard.
- Check valve in suction cone to prevent loss of prime during temporary shut-down periods.



MALE CAMLOCK x FPT

Part #	Size
106-075A	3/4"
106-100A	1"
106-150A	1 1/2"
106-200A	2"
106-300A	3"



FEMALE COUPLER x FPT

Part #	Size
106-075D	3/4"
106-100D	1"
106-150D	1 1/2"
106-200D	2"
106-300D	3"



CAP (MALE ADAPTER)

Part #	Size
106-075CAP	3/4"
106-100CAP	1"
106-150CAP	1 1/2"
106-200CAP	2"
106-300CAP	3"



MALE CAMLOCK x MPT

Part #	Size
106-075F	3/4"
106-100F	1"
106-150F	1 1/2"
106-200F	2"
106-300F	3"



FEMALE COUPLER x MPT

Part #	Size
106-075B	3/4"
106-100B	1"
106-150B	1 1/2"
106-200B	2"
106-300B	3"



PLUG (FEMALE COUPLER)

Part #	Size
106-075PL	3/4"
106-100PL	1"
106-150PL	1 1/2"
106-200PL	2"
106-300PL	3"



MALE CAMLOCK x HOSE

Part #	Size
106-075E	3/4"
106-100E	1"
106-150E	1 1/2"
106-200E	2"
106-300E	3"



FEMALE COUPLER x HOSE

Part #	Size
106-075C	3/4"
106-100C	1"
106-150C	1 1/2"
106-200C	2"
106-300C	3"



POLY HOSE BARB

Part #	Size
106-HB075	3/4"
106-HB100	1"
106-HB150	1 1/2"
106-HB200	2"
106-HB300	3"



POLY 90° ELBOW

Part #	Size
106-EL100-90	1"
106-EL200-90	2"
106-EL300-90	3"



POLY 45° ELBOW

Part #	Size
106-EL100-45	1"



POLY HOSE MENDER

Part #	Size
106-HM200	2"
106-HM300	3"



POLY 90° STREET ELBOW

Part #	Size
106-SL200-90	2"
106-SL300-90	3"



POLY 45° STREET ELBOW

Part #	Size
106-SL200-45	2"
106-SL300-45	3"



POLY TEE

Part #	Size
106-TEE200	2"
106-TEE300	3"



POLY NIPPLE

Part #	Size
106-NIP200-SH	2" Short
106-NIP200-4	2" x 4"
106-NIP200-6	2" x 6"
106-NIP300-SH	3" Short
106-NIP300-4	3" x 4"
106-NIP300-6	3" x 6"
106-NIP400-SH	4" Short



TANK FLANGE GASKET

Part #	Description
106-TF220G	2" Flange Gasket
106-TF300G	3" Flange Gasket



POLY BULKHEAD FITTING

Part #	Description	Hole Size
106-TF200	2" EPDM Tank Fitting	3"
106-TF300	3" EPDM Tank Fitting	4 1/2"



BOLTED BALL VALVE - FULL PORT

Part #	Size	# of Bolts
106-V100FP	1"	4
106-V150	1-1/2"	4
106-V200FP	2"	6
106-V300FP	3"	6



BALL VALVE REPLACEMENT HANDLE

Part #	Description
106-VS20152SH	2" Short Style Handle
106-V25153	Handle - Straight
106-V25270	Valve Mounting Bracket - Straight
106-V25271	Valve Mounting Bracket - 90°



Y-STRAINER FPT x FPT

Part #	Description
106-LS200-50	2" w/ Poly Ribbed SS Screen
106-LSM300-50	3" w/ Poly Ribbed SS Screen



For a complete list of Banjo fittings available, please visit their website at www.banjocorp.com

MANIFOLD FLANGE CONNECTIONS

<p>FLANGE x MPT</p> <table style="width: 100%; border-collapse: collapse;"> <thead> <tr> <th style="text-align: left; border-bottom: 1px solid black;">Part #</th> <th style="text-align: left; border-bottom: 1px solid black;">Size</th> </tr> </thead> <tbody> <tr> <td>106-M220MPT</td> <td>2"</td> </tr> <tr> <td>106-M300MPT</td> <td>3"</td> </tr> </tbody> </table> 	Part #	Size	106-M220MPT	2"	106-M300MPT	3"	<p>FLANGED TEE</p> <table style="width: 100%; border-collapse: collapse;"> <thead> <tr> <th style="text-align: left; border-bottom: 1px solid black;">Part #</th> <th style="text-align: left; border-bottom: 1px solid black;">Size</th> </tr> </thead> <tbody> <tr> <td>106-M220TEE</td> <td>2"</td> </tr> <tr> <td>106-M300TEE</td> <td>3"</td> </tr> </tbody> </table> 	Part #	Size	106-M220TEE	2"	106-M300TEE	3"	<p>FLANGE X HOSE BARB</p> <table style="width: 100%; border-collapse: collapse;"> <thead> <tr> <th style="text-align: left; border-bottom: 1px solid black;">Part #</th> <th style="text-align: left; border-bottom: 1px solid black;">Size</th> </tr> </thead> <tbody> <tr> <td>106-M220BRB</td> <td>2"</td> </tr> <tr> <td>106-M300BRB</td> <td>3"</td> </tr> </tbody> </table> 	Part #	Size	106-M220BRB	2"	106-M300BRB	3"
Part #	Size																			
106-M220MPT	2"																			
106-M300MPT	3"																			
Part #	Size																			
106-M220TEE	2"																			
106-M300TEE	3"																			
Part #	Size																			
106-M220BRB	2"																			
106-M300BRB	3"																			
<p>FLANGE x FPT</p> <table style="width: 100%; border-collapse: collapse;"> <thead> <tr> <th style="text-align: left; border-bottom: 1px solid black;">Part #</th> <th style="text-align: left; border-bottom: 1px solid black;">Size</th> </tr> </thead> <tbody> <tr> <td>106-M220FPT</td> <td>2"</td> </tr> <tr> <td>106-M300FPT</td> <td>3"</td> </tr> </tbody> </table> 	Part #	Size	106-M220FPT	2"	106-M300FPT	3"	<p>FLANGED 90° ELBOW</p> <table style="width: 100%; border-collapse: collapse;"> <thead> <tr> <th style="text-align: left; border-bottom: 1px solid black;">Part #</th> <th style="text-align: left; border-bottom: 1px solid black;">Size</th> </tr> </thead> <tbody> <tr> <td>106-M220CPG90</td> <td>2"</td> </tr> <tr> <td>106-M300CPG90</td> <td>3"</td> </tr> </tbody> </table> 	Part #	Size	106-M220CPG90	2"	106-M300CPG90	3"	<p>FLANGE X 45° HOSE BARB ELBOW</p> <table style="width: 100%; border-collapse: collapse;"> <thead> <tr> <th style="text-align: left; border-bottom: 1px solid black;">Part #</th> <th style="text-align: left; border-bottom: 1px solid black;">Size</th> </tr> </thead> <tbody> <tr> <td>106-M220BRB45</td> <td>2"</td> </tr> </tbody> </table> 	Part #	Size	106-M220BRB45	2"		
Part #	Size																			
106-M220FPT	2"																			
106-M300FPT	3"																			
Part #	Size																			
106-M220CPG90	2"																			
106-M300CPG90	3"																			
Part #	Size																			
106-M220BRB45	2"																			
<p>FLANGE x MALE ADAPTER</p> <table style="width: 100%; border-collapse: collapse;"> <thead> <tr> <th style="text-align: left; border-bottom: 1px solid black;">Part #</th> <th style="text-align: left; border-bottom: 1px solid black;">Size</th> </tr> </thead> <tbody> <tr> <td>106-M220A</td> <td>2"</td> </tr> </tbody> </table> 	Part #	Size	106-M220A	2"	<p>FLANGE x FEMALE COUPLER</p> <table style="width: 100%; border-collapse: collapse;"> <thead> <tr> <th style="text-align: left; border-bottom: 1px solid black;">Part #</th> <th style="text-align: left; border-bottom: 1px solid black;">Size</th> </tr> </thead> <tbody> <tr> <td>106-M220D</td> <td>2"</td> </tr> </tbody> </table> 	Part #	Size	106-M220D	2"	<p>FLANGE GASKET (Full Port)</p> <table style="width: 100%; border-collapse: collapse;"> <thead> <tr> <th style="text-align: left; border-bottom: 1px solid black;">Part #</th> <th style="text-align: left; border-bottom: 1px solid black;">Size</th> </tr> </thead> <tbody> <tr> <td>106-M221G</td> <td>2"</td> </tr> </tbody> </table> 	Part #	Size	106-M221G	2"						
Part #	Size																			
106-M220A	2"																			
Part #	Size																			
106-M220D	2"																			
Part #	Size																			
106-M221G	2"																			
<p>For a complete list of Banjo fittings available, please visit their website at www.banjocorp.com</p>																				
<p>REDUCING BUSHING</p> <table style="width: 100%; border-collapse: collapse;"> <thead> <tr> <th style="text-align: left; border-bottom: 1px solid black;">Part #</th> <th style="text-align: left; border-bottom: 1px solid black;">Size</th> </tr> </thead> <tbody> <tr> <td>106-RB200-150</td> <td>2"x1 1/2"</td> </tr> <tr> <td>106-RB300-200</td> <td>3"x2"</td> </tr> </tbody> </table> 	Part #	Size	106-RB200-150	2"x1 1/2"	106-RB300-200	3"x2"	<p>POLY CAP - THREADED</p> <table style="width: 100%; border-collapse: collapse;"> <thead> <tr> <th style="text-align: left; border-bottom: 1px solid black;">Part #</th> <th style="text-align: left; border-bottom: 1px solid black;">Size</th> </tr> </thead> <tbody> <tr> <td>106-CAP100</td> <td>1"</td> </tr> <tr> <td>106-CAP200</td> <td>2"</td> </tr> </tbody> </table> 	Part #	Size	106-CAP100	1"	106-CAP200	2"	<p>REDUCING COUPLING</p> <table style="width: 100%; border-collapse: collapse;"> <thead> <tr> <th style="text-align: left; border-bottom: 1px solid black;">Part #</th> <th style="text-align: left; border-bottom: 1px solid black;">Size</th> </tr> </thead> <tbody> <tr> <td>106-M300220CPG</td> <td>3"x 2" Full Port</td> </tr> </tbody> </table> 	Part #	Size	106-M300220CPG	3"x 2" Full Port		
Part #	Size																			
106-RB200-150	2"x1 1/2"																			
106-RB300-200	3"x2"																			
Part #	Size																			
106-CAP100	1"																			
106-CAP200	2"																			
Part #	Size																			
106-M300220CPG	3"x 2" Full Port																			
<p>MANIFOLD VALVE - FLANGE x FLANGE</p> <table style="width: 100%; border-collapse: collapse;"> <thead> <tr> <th style="text-align: left; border-bottom: 1px solid black;">Part #</th> <th style="text-align: left; border-bottom: 1px solid black;">Size</th> </tr> </thead> <tbody> <tr> <td>106-MVS220CF</td> <td>2" Full Port</td> </tr> <tr> <td>106-MVS300CFPP</td> <td>3" Full Port</td> </tr> </tbody> </table> 	Part #	Size	106-MVS220CF	2" Full Port	106-MVS300CFPP	3" Full Port	<p>MANIFOLD "Y" LINE STRAINER</p> <table style="width: 100%; border-collapse: collapse;"> <thead> <tr> <th style="text-align: left; border-bottom: 1px solid black;">Part #</th> <th style="text-align: left; border-bottom: 1px solid black;">Size</th> </tr> </thead> <tbody> <tr> <td>106-MLS200-50</td> <td>2" Y Line Strainer with 50 Mesh Screen</td> </tr> </tbody> </table> 	Part #	Size	106-MLS200-50	2" Y Line Strainer with 50 Mesh Screen	<p>WORM SCREW CLAMP</p> <table style="width: 100%; border-collapse: collapse;"> <thead> <tr> <th style="text-align: left; border-bottom: 1px solid black;">Part #</th> <th style="text-align: left; border-bottom: 1px solid black;">Size</th> </tr> </thead> <tbody> <tr> <td>106-FC221HD</td> <td>2"</td> </tr> <tr> <td>106-FC300</td> <td>3"</td> </tr> </tbody> </table> 	Part #	Size	106-FC221HD	2"	106-FC300	3"		
Part #	Size																			
106-MVS220CF	2" Full Port																			
106-MVS300CFPP	3" Full Port																			
Part #	Size																			
106-MLS200-50	2" Y Line Strainer with 50 Mesh Screen																			
Part #	Size																			
106-FC221HD	2"																			
106-FC300	3"																			
<p>FLOW METERS - FULL PORT</p>																				
																				
<table style="width: 100%; border-collapse: collapse;"> <thead> <tr> <th style="text-align: left; border-bottom: 1px solid black;">Part #</th> <th style="text-align: left; border-bottom: 1px solid black;">Size</th> </tr> </thead> <tbody> <tr> <td>106-FM100</td> <td>1" Full Port Female NPT Flow Meter</td> </tr> </tbody> </table>	Part #	Size	106-FM100	1" Full Port Female NPT Flow Meter	<table style="width: 100%; border-collapse: collapse;"> <thead> <tr> <th style="text-align: left; border-bottom: 1px solid black;">Part #</th> <th style="text-align: left; border-bottom: 1px solid black;">Size</th> </tr> </thead> <tbody> <tr> <td>106-MFM100</td> <td>1" Full Port Manifold Flow Meter (Male)</td> </tr> </tbody> </table>	Part #	Size	106-MFM100	1" Full Port Manifold Flow Meter (Male)	<table style="width: 100%; border-collapse: collapse;"> <thead> <tr> <th style="text-align: left; border-bottom: 1px solid black;">Part #</th> <th style="text-align: left; border-bottom: 1px solid black;">Size</th> </tr> </thead> <tbody> <tr> <td>106-MFM220</td> <td>2" Full Port Manifold Flow Meter (Male)</td> </tr> </tbody> </table>	Part #	Size	106-MFM220	2" Full Port Manifold Flow Meter (Male)						
Part #	Size																			
106-FM100	1" Full Port Female NPT Flow Meter																			
Part #	Size																			
106-MFM100	1" Full Port Manifold Flow Meter (Male)																			
Part #	Size																			
106-MFM220	2" Full Port Manifold Flow Meter (Male)																			

COUPLER x FEMALE NPT

Part #	Size
45-AL-D075	3/4"
45-AL-D100	1"
45-AL-D150	1-1/2"
45-AL-D200	2"
45-AL-D300	3"
45-AL-D400	4"
45-AL-D600	6"
45-AL-D 800	8"



COUPLER x HOSE SHANK

Part #	Size
45-AL-C075	3/4"
45-AL-C100	1"
45-AL-C150	1-1/2"
45-AL-C200	2"
45-AL-C300	3"
45-AL-C400	4"
45-AL-C600	6"
45-AL-C800	8"



COUPLER x MALE NPT

Part #	Size
45-AL-B075	3/4"
45-AL-B100	1"
45-AL-B150	1-1/2"
45-AL-B200	2"
45-AL-B300	3"
45-AL-B400	4"
45-AL-B600	6"
45-AL-B800	8"



ADAPTER x FEMALE NPT

Part #	Size
45-AL-A075	3/4"
45-AL-A100	1"
45-AL-A150	1-1/2"
45-AL-A200	2"
45-AL-A300	3"
45-AL-A400	4"
45-AL-A600	6"
45-AL-A800	8"



ADAPTER x HOSE SHANK

Part #	Size
45-AL-E075	3/4"
45-AL-E100	1"
45-AL-E150	1-1/2"
45-AL-E200	2"
45-AL-E300	3"
45-AL-E400	4"
45-AL-E600	6"
45-AL-E800	8"



ADAPTER x MALE NPT

Part #	Size
45-AL-F075	3/4"
45-AL-F100	1"
45-AL-F150	1-1/2"
45-AL-F200	2"
45-AL-F300	3"
45-AL-F400	4"
45-AL-F600	6"
45-AL-F800	8"



DUST CAP



Part #	Size
45-AL-DC075	3/4"
45-AL-DC100	1"
45-AL-DC150	1-1/2"
45-AL-DC200	2"
45-AL-DC300	3"
45-AL-DC400	4"
45-AL-DC600	6"
45-AL-DC800	8"

DUST PLUG



Part #	Size
45-AL-DP075	3/4"
45-AL-DP100	1"
45-AL-DP150	1-1/2"
45-AL-DP200	2"
45-AL-DP300	3"
45-AL-DP400	4"
45-AL-DP600	6"
45-AL-DP800	8"

REPLACEMENT GASKET



Part #	Size
45-BUNA075	3/4"
45-BUNA100	1"
45-BUNA150	1-1/2"
45-BUNA200	2"
45-BUNA300	3"
45-BUNA400	4"
45-BUNA600	6"
45-BUNA800	8"

REPLACEMENT HANDLE



Part #	Size
45-HABRASS-100	1" - 1-1/2"
45-HABRASS-200	1-1/2" - 2-1/2"
45-HABRASS-300	3" - 5"
45-HABRASS-600	6" - 8"



Kuriyama of America, Inc.

Brass, Stainless Steel, Polypropylene, along with other sizes available upon request.

TIGERFLEX HOSE YELLOW EPDM DISCHARGE & SUCTION HOSE
(Working Pressure 65 PSI @ 68')



Part #	Size
45-TY200x100	2"
45-TY300x100	3"

TIGERFLEX HOSE BLACK EPDM DISCHARGE & SUCTION HOSE
(Working Pressure 100 PSI @ 68')



Part #	Size
45-TSD200x100	2"
45-TSD300x100	3"

TIGERFLEX HOSE "H" SERIES DISCHARGE & SUCTION HOSE
(Working Pressure 65 PSI @ 68')



Part #	Size
45-HG150x100	1-1/2"
45-HG200x100	2"

SINGLE BOLT CLAMP FOR TIGERFLEX HOSE

Part #	Size
72-4650.09	1-1/2"
72-4650.13	2"
72-4650.18	3"



CENTER PUNCH TOOL



Part #	Size
60-HBC300	5/8" Punch Tool

BAND-IT® CENTER PUNCH CLAMP

Part #	Size
23-CP12S9	3" x 5/8"
23-CP16S9	4" x 5/8"
23-CP24S9	6" x 5/8"
23-CP32S9	8" x 5/8"



90° B&L REVERSIBLE ELBOW 

Part #	Size
03-P1103-61	2"
03-P1104-61	3"
03-P1105-61	4"
03-P1106-61	5"
03-P1107-61	6"

90° RINGLOCK ELBOW - ALUMINUM 

Part #	Size
16-HPFE400	4"
16-HPFE600	6"
16-HPFE800	8"

90° RINGLOCK ELBOW - STEEL 

Part #	Size
03-P1796-62	4"
03-P1797-61	6"
03-P1797-63	8"

45° B&L REVERSIBLE ELBOW 

Part #	Size
03-P1121-61	2"
03-P1122-61	3"
03-P1123-61	4"
03-P1124-61	5"
03-P1125-61	6"

45° RINGLOCK ELBOW - ALUMINUM 

Part #	Size
16-HPFE400 45	4"
16-HPFE600 45	6"
16-HPFE800 45	8"

45° RINGLOCK ELBOW - STEEL 

Part #	Size
03-P1799-62	4"
03-P1798-61	6"
03-P1798-63	8"

BAND & LATCH END PLUG 

Part #	Size
03-P1087-01	2"
03-P1087-02	3"
03-P1087-03	4"
03-P1087-04	5"
03-P1087-05	6"

RINGLOCK END PLUG - ALUMINUM 

Part #	Size
16-HPEP400	4"
16-HPEP600	6"
16-HPEP800	8"

RINGLOCK END PLUG - STEEL 

Part #	Size
03-P3206-01	4"
03-P3206-03	6"
03-P3206-05	8"

BAND & LATCH END TEE 

Part #	Size
03-P1079-61	2"
03-P1077-61	3"
03-P1077-62	4"
03-P1078-62	6"

RINGLOCK END TEE - ALUMINUM 

Part #	Size
16-HPET400	4"
16-HPET600	6"
16-HPET800	8"

RINGLOCK END TEE - STEEL 

Part #	Size
03-P1181-61	4"
03-P1181-63	6"
03-P1181-65	8"

BAND & LATCH LINE TEE 

Part #	Size
03-P1092-61	2"
03-P1091-62	3"
03-P1090-63	4"
03-P1089-64	6"

RINGLOCK LINE TEE - ALUMINUM 

Part #	Size
16-HPFT400	4"
16-HPFT600	6"
16-HPFT800	8"

RINGLOCK LINE TEE - STEEL 

Part #	Size
03-P1504-62	4"
03-P1506-64	6"
03-P1507-65	8"

BOLT-ON COUPLER SET 

Part #	Size
16-CLO400	4"
16-CLO600	6"

BAND & LATCH REDUCER 

Part #	Size
03-P1085-61	3" x 2"
03-P1085-62	4" x 2"
03-P1085-63	4" x 3"
03-P1085-64	5" x 3"
03-P1085-65	5" x 4"
03-P1085-68	6" x 4"
03-P1085-69	6" x 5"

**ALUMINUM
45° WELDING
ELBOW**

Part #	Size
16-WE43	3"
16-WE44	4"
16-WE45	5"
16-WE46	6"
16-WE48	8"

**ALUMINUM
90° WELDING
ELBOW**

Part #	Size
16-WE93	3"
16-WE94	4"
16-WE95	5"
16-WE96	6"
16-WE98	8"

**WELD-ON
END PLUG
COVER**

Part #	Size
16-WEPC600	6"
16-WEPC700	7"
16-WEPC800	8"
16-WEPC1000	10"

**ALUMINUM
WELDING
CONE**

Part #	Size
16-WC302	3 x 2
16-WC402	4 x 2
16-WC403	4 x 3
16-WC406	6 x 4
16-WC608	6 x 8
16-WC8010	8 x 10
16-WC1012	10 x 12

**ALUMINUM
HALF
COUPLING**

Part #	Size
16-HC100	1"
16-HC125	1 1/4"
16-HC150	1 1/2"
16-HC200	2"
16-HC250	2 1/2"
16-HC300	3"
16-HC400	4"
16-HC500	5"
16-HC600	6"
16-HC800	8"

**ALUMINUM
HALF
NIPPLE**

Part #	Size
16-NA100	1"
16-NA125	1 1/4"
16-NA150	1 1/2"
16-NA200	2"
16-NA250	2 1/2"
16-NA300	3"
16-NA400	4"
16-NA500	5"
16-NA600	6"
16-NA800	8"

**WELD-ON
MALE END
(RINGLOCK)**

Part #	Size
16-HPM400	4"
16-HPM600	6"
16-HPM800	8"
16-HPM1000	10"

**WELD-ON
COUPLER
(RINGLOCK)**

Part #	Size
16-HPF400	4"
16-HPF600	6"
16-HPF800	8"
16-HPF1000	10"

**ALUMINUM
WELDING
TEE**

Part #	Size
16-WT444	4"
16-WT666	6"
16-WT888	8"
16-WT101010	10"

**ALUMINUM
WELD-ON
FLANGE**

Part #	Size
16-APF300	3"
16-APF400	4"
16-APF600	6"
16-APF800	8"
16-APF1000	10"

**ALUMINUM
WELDING
DISC**

Part #	Size
16-AWD-4	4"
16-AWD-6	6"
16-AWD-8	8"

**ALUMINUM
WELD-ON
RING**

Part #	Size
16-R600	6"
16-R800	8"

**SADDLE
COUPLING**

Part #	Size
16-SC075	3/4"
16-SC100	1"

**WELD-ON
LATCH POCKET**

Part #	Size
16-WLP34	3" x 4"
16-WLP56	5" x 6"

**WELD-ON
HOOK BRACKET**

Part #
16-WHB

Additional styles and sizes are available upon request.

Please call for more information.

HOSE TO COUPLER
Hose Adapters used to connect hose to Ringlock fittings. Includes roundback gasket.



Part #	Hose Barb	Ringlock Bell
03-P1842-62	4" OD	4"
03-P1842-64	6" OD	6"
03-P1842-65	8" OD	8"

HOSE TO MALE END
Hose Adapters used to connect hose to Ringlock fittings.



Part #	Hose Barb	Ringlock Male End
03-P1843-02	4" OD	4"
03-P1843-04	6" OD	6"
03-P1843-05	8" OD	8"

HOSE TO FEMALE UNIVERSAL BELL
Hose Adapters used to connect hose to Universal lateral fittings. Includes roundback gasket.



Part #	Hose Barb	Universal Bell
03-P1788-62	3" OD	3"
03-P1788-63	4" OD	4"
03-P1788-65	6" OD	6"

HOSE TO UNIVERSAL MALE END



Part #	Hose Barb	Universal Male End
03-P1791-02	3" OD	3"
03-P1791-04	4" OD	4"
03-P1791-07	6" OD	6"

REDUCING HOSE x RINGLOCK FEMALE



Part #	Hose Barb	Ringlock Female End
03-P3458-06	4" OD	6"

REDUCING HOSE x RINGLOCK MALE



Part #	Hose Barb	Ringlock Male End
03-P3108-06	4" OD	6"

RINGLOCK BOLT-ON RING



Part #	Size
22-BOLTM06	6"
22-BOLTM08	8"

REDUCING HOSE x FEMALE BAND & LATCH



Part #	Hose Barb	Universal Female End
03-P0019-27	4" OD	6"

REDUCING HOSE x MALE BAND & LATCH



Part #	Hose Barb	Universal Male End
03-P0019-26	4" OD	6"

HOSE BARB x RINGLOCK COUPLER

Part #	Description
100-6HBX6RLC	6" Hose x 6" RL Coupler
100-8HBX8RLC	8" Hose x 8" RL Coupler



HOSE BARB x RINGLOCK MALE END

Part #	Description
100-6HBX6RLM	6" Hose x 6" RL Male End
100-8HBX8RLM	8" Hose x 8" RL Male End



FEMALE RINGLOCK x FLANGE ADAPTER



Part #	Size
22-FLFE06G	6"
22-FLFE08G	8"

MALE RINGLOCK x FLANGE ADAPTER



Part #	Size
22-FLME06G	6"
22-FLME08G	8"

GALVANIZED FLANGED 90° ELBOW



Part #	Size
22-FL9004G	4"
22-FL9006G	6"
22-FL9008G	8"

GALVANIZED FLANGED TEE



Part #	Size
22-FLTE06G	6"
22-FLTE08G	8"

MALE PIPE THREAD x FLANGE ADAPTER



Part #	Size
22-FLMT0604G	4" x 6"
22-FLMT0606G	6" x 6"
22-FLMT0806G	6" x 8"

STEEL WELDING RINGS (FOR IRRIGATION APPLICATIONS)



Part #	Size
100-P0044-77	6"
100-P0047-79	8"

Additional combinations and sizes available as well as fabrication of fittings. Please call for more details.

PE TUBE SCREW-IN MENDER for 0.86 Inch - 2.3 Inch Polyethylene Tube



1)

INSTALLATION INSTRUCTIONS:

STEP 1: Cut hose on either side of damaged area. Make good, straight cuts. Use block of wood or soft hammer to tap collar fully onto end of hose.



2)

STEP 2: Chamfer hose internally with knife or coarse file so that end of screw-in mender will enter hose.



3)

STEP 3: Screw mender about 2/3rds into end of hose, using a wrench on the center knurled shoulder. Important: Please note mender threads are different at each end. One is left-hand and one is right-hand. Unscrew mender from first end and repeat procedure for second end. Watch for left-hand thread. After screwing it in 2/3rds of the way, unscrew it again.



4)

STEP 4: Now start mender in both ends of hose simultaneously. As is screws in, it will draw both ends of the hose to the center. This time, screw it all the way to the shoulder. The hose should now be ready to go immediately back into service.



Part #	Description
25-K58502333	27mm x 0.9" ID
25-K58502335	33mm x 1.1" ID
25-K58502328	40mm x 1.3" ID
25-K58502336	43mm x 1.4" ID
25-K58502329	50mm x 1.6" ID
25-K58502334	55mm x 1.8" ID
25-K58502327	58mm x 1.9" ID
25-K58502331	63mm x 2.1" ID
25-K58502337	70mm x 2.3" ID

PE TUBE SCREW-IN MENDER for 2.5 Inch - 4.5 Inch Polyethylene Tube

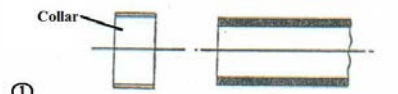

①

INSTALLATION INSTRUCTIONS:

Step 1: Cut tube on either side of damaged area. Clamp or hold tube in vice. Insure sharp corners do not cut tube. Press or tap collar fully onto end of tube.

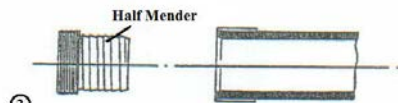

②

Step 2: Chamfer tube internally with tapered reamer or coarse file so that end of screw-in mender will enter tube.

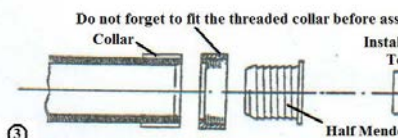

③

Step 3: Locate installation tool in half mender and push it into end of tube. Simultaneously push and rotate tool clockwise. As soon as mender starts to bite, it will cut its own thread. Screw mender fully into end of tube. After removing tool, clear away any shreds of polyethylene from inside tube.

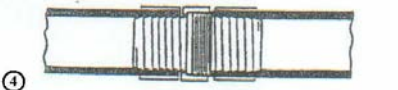

④

Step 4: After fitting both halves of mender, couple them with threaded collar. Insure that any natural curve of tube is maintained when joining mender.



Part #	Description
19-588-0359-0	PE Tube Reamer for 135mm-75mm Tube
19-593-0295-0	Reamer Handle
19-585-0232-6	75mm x 2.5" ID
19-585-0232-5	82mm x 2.7" ID
19-585-0232-4	90mm x 3.0" ID
19-585-0232-3	100mm x 3.3" ID
19-585-0232-2	110mm x 3.7" ID
19-585-0233-2	120mm x 4.0" ID
19-585-0232-1	125mm x 4.1" ID
19-585-0232-0	135mm x 4.5" ID

HOSE PULL COUPLER for 4.0 Inch - 5.0 Inch Hose



INSTALLATION INSTRUCTIONS

STEP 1: Cut end of hose off square, then measure 3" from hose end and mark all the way around. Cut four evenly spaced slits on even quarters exactly 3" deep to mark you made. CAUTION: Be sure to make no less than four slits evenly spaced. Tabs wider than 1/4 of hose circumference will wrinkle on coupler causing uneven tension on hose strands resulting in premature failure. Also make sure slits are of equal 3" depth. Uneven depth of slits will cause coupler to "cock" to one side, concentrating pull on one side of hose, resulting in premature failure. Slits less than 3" deep permit insufficient contact between hose and coupler resulting in decreased pull capacity.

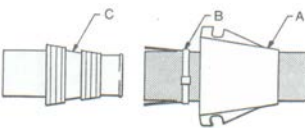

STEP 2: Place outer coupler member (A) and Punch-Lok Band (B) over prepared hose end as shown. Do not tighten Punch-Lok Band yet.

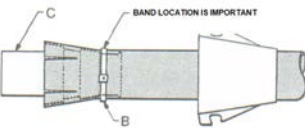

STEP 3: Insert inner coupler member (C) into hose end as far as possible. Position band around untapered recess of inner coupler member (C) as shown next to tapered shoulder making sure slits are well forward of band. Slits under band will cause leaking.

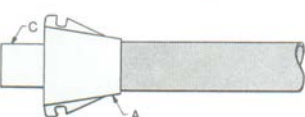

STEP 4: Tighten Punch-Lok Band (B) securely with Punch-Lok Tool.



Part #	Description
62-5-60120	4" x 4"
62-5-60130	4-1/2" x 4"

HOSE BARB - 12 Gauge

Part #	Size
03-P1790-02	3"
03-P1790-04	4"
03-P1790-06	5"
03-P1790-07	6"
03-P1790-08	8"
03-P1790-09	10"



SHUG GRIP COUPLER WELD-ON HOSE BARB

Part #	Size
100-SWOHB4	4"
100-SWOHB6	6"
100-HSGW8w/o	8" (excludes clamp)



COMPRESSION COUPLING (PVC)



STEEL HOSE MENDER

Part #	Size
45-SPHM200	2"
45-SPHM300	3"
45-SPHM400	4"
45-SPHM600	6"
45-SPHM800	8"
45-SPHM1000	10"
45-SPHM1200	12"



SHUG GRIP MENDER SET

Part #	Size
20-M3MCS4A	4"
20-M3MCS45A	4.5"
20-M3MCS5A	5"
20-M3MCS55A	5.5"
20-M3MCS6A	6"
20-M3MCS7A	7"
20-M3MCS8A	8"
20-M3MCS10A	10"



Part #	Size
26-S110-15	1 1/2"
26-S110-20	2"
26-S110-25	2 1/2"
26-S110-30	3"
26-S110-40	4"
26-S110-60	6"

STEEL PLATED HOSE NIPPLE

Part #	Size
45-SPN050	1/2"
45-SPN075	3/4"
45-SPN100	1"
45-SPN150	1 1/2"
45-SPN200	2"
45-SPN250	2 1/2"
45-SPN300	3"
45-SPN400	4"
45-SPN600	6"
45-SPN800	8"



SHUG GRIP MAIN / DRAG COUPLER SET

Part #	Size
20-M3CS4A	4"
20-M3CS45A	4.5"
20-M3CS5A	5"
20-M3CS55A	5.5"
20-M3CS6A	6"
20-M3CS7A	7"
20-M3CS725A	7.25"
20-M3CS8A	8"
20-M3CS10A	10"



FLO SPAN COUPLING (PVC)



Part #	Size
77-460T07	1 1/2"
77-460T08	2"
77-460T09	2 1/2"
77-460T10	3"
77-460T11	4"

FLEXIBLE RUBBER COUPLING (Fernco Style with SS Bands)

Part #	Size
77-4561010	3"
77-4561111	4"
77-4561313	6"



Reducing Couplings, End Caps, & Other Sizes Available Upon Request

WEDGE-TITE REPAIR COUPLER SET 16" BODY

Part #	Size
03-P9085-01	6" IPS
03-P9086-01	8" IPS
03-P9087-01	10" IPS
03-P9088-01	12" IPS



HARD MENDERS (Soft Hose Travelers)



Part #	Size
100-HM40	4"
100-HM45	4 1/2"

LAY-FLAT INSERT COUPLING (Insert x Insert)



Part #	Description
54-C-02	2" Lay-Flat Insert Coupling
54-C-03	3" Lay-Flat Insert Coupling
54-C-04	4" Lay-Flat Insert Coupling
54-C-05	5" Lay-Flat Insert Coupling
54-C-06	6" Lay-Flat Insert Coupling
54-C-08	8" Lay-Flat Insert Coupling

SLIP COUPLING (PVC) (Slip x Slip)



Part #	Description
26-429-005	1/2" Slip Coupling
26-429-007	3/4" Slip Coupling
26-429-010	1" Slip Coupling
26-429-012	1 1/4" Slip Coupling
26-429-015	1 1/2" Slip Coupling
26-429-020	2" Slip Coupling
26-429-025	2 1/2" Slip Coupling
26-429-030	3" Slip Coupling
26-429-040	4" Slip Coupling
26-429-050	5" Slip Coupling
26-429-060	6" Slip Coupling

REPAIR COUPLER (Galvanized)



Part #	Size
03-P1578-21	4"
03-P1578-22	6"
03-P1578-23	8"
03-P1578-24	10"

**FOOT VALVE
45°
FLANGED
OD TUBING**



Part #	Size
02-SFV2	2"
02-SFV3	3"
02-SFV4	4"
02-SFV5	5"
02-SFV6	6"
02-SFV8	8"

**FOOT VALVE
45°
FEMALE
THREAD**



Part #	Size
02-SFV2FP	2"
02-SFV3FP	3"
02-SFV4FP	4"
02-SFV5FP	5"
02-SFV6FP	6"
02-SFV8FP	8"

**FOOT VALVE
45°
COMPANION
FLANGE**



Part #	Size
02-SFV2CF	2"
02-SFV3CF	3"
02-SFV4CF	4"
02-SFV5CF	5"
02-SFV6CF	6"
02-SFV8CF	8"

**STRAINER
FOR
PVC PIPE**



Part #	Size
02-SPVC4	4"
02-SPVC6	6"
02-SPVC8	8"
02-SPVC10	10"
02-SPVC12	12"
02-SPVC15	15"

**FOOT VALVE
VERTICAL
OD TUBING**



Part #	Size
02-SFVV3	3"
02-SFVV4	4"
02-SFVV5	5"
02-SFVV6	6"
02-SFVV8	8"

**FOOT VALVE
VERTICAL
FEMALE
THREAD**



Part #	Size
02-SFVV2FP	2"
02-SFVV3FP	3"
02-SFVV4FP	4"
02-SFVV5FP	5"
02-SFVV6FP	6"
02-SFVV8FP	8"

**FOOT VALVE
VERTICAL
COMPANION
FLANGE**



Part #	Size
02-SFVV2CF	2"
02-SFVV3CF	3"
02-SFVV4CF	4"
02-SFVV5CF	5"
02-SFVV6CF	6"
02-SFVV8CF	8"

**INTAKE
STRAINER**



Part #	Size
02-SFS2	2"
02-SFS3	3"
02-SFS4	4"
02-SFS5	5"
02-SFS6	6"
02-SFS8	8"

**90° SUCTION
ELBOW**



Part #	Size
02-SFE92	2"
02-SFE93	3"
02-SFE94	4"
02-SFE95	5"
02-SFE96	6"
02-SFE98	8"
02-SFE910	10"

**45° SUCTION
ELBOW**



Part #	Size
02-SFE42	2"
02-SFE43	3"
02-SFE44	4"
02-SFE45	5"
02-SFE46	6"
02-SFE48	8"
02-SFE410	10"

**INTAKE
COUPLING**



Part #	Size
02-SFC2	2"
02-SFC3	3"
02-SFC4	4"
02-SFC5	5"
02-SFC6	6"
02-SFC8	8"
02-SFC10	10"

**SELF-
CLEANING
STRAINER**



Part #	Size
02-SCS2	2"
02-SCS3	3"
02-SCS4	4"
02-SCS6	6"
02-SCS8	8"

**INTAKE
ADAPTER**

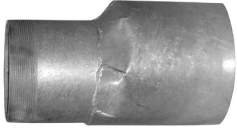

Part #	Size	Part #	Size
02-SFA152	1 1/2" x 2"	02-SFA45	4" x 5"
02-SFA22	2" x 2"	02-SFA46	4" x 6"
02-SFA23	2" x 3"	02-SFA48	4" x 8"
02-SFA24	2" x 4"	02-SFA55	5" x 5"
02-SFA253	2 1/2" x 3"	02-SFA56	5" x 6"
02-SFA33	3" x 3"	02-SFA58	5" x 8"
02-SFA34	3" x 4"	02-SFA66	6" x 6"
02-SFA35	3" x 5"	02-SFA68	6" x 8"
02-SFA36	3" x 6"	02-SFA88	8" x 8"
02-SFA44	4" x 4"		

**DISCHARGE
ADAPTER**



Part #	Size
03-P1739-63	2" x 2"
03-P1740-63	2" x 3"
03-P1739-65	3" x 3"
03-P1740-65	2" x 4"
03-P1740-67	3" x 4"
03-P0029-25	4" x 4"
03-P0009-06	4" x 6"
03-P1740-74	5" x 6"
03-P0014-38	6" x 6"
03-P3116-73	6" x 8"

**HORIZONTAL
STRAINER**



Part #	Size
02-SFSH4	4"
02-SFSH6	6"
02-SFSH8	8"

(With Foot Valve)

02-SFSHV4	4"
02-SFSHV6	6"
02-SFSHV8	8"

FOOT VALVE PARTS

FLAPPER GSKT ASSEMBLY



Part	Size
02-VFG2A	2"
02-VFG3A	3"
02-VFG4A	4"
02-VFG5A	5"
02-VFG6A	6"
02-VFG8A	8"

FLAPPER GASKET



Part	Size
02-VFG2	2"
02-VFG3	3"
02-VFG4	4"
02-VFG5	5"
02-VFG6	6"
02-VFG8	8"

VALVE SEAT RING



Part	Size
02-VSR2	2"
02-VSR3	3"
02-VSR4	4"
02-VSR5	5"
02-VSR6	6"
02-VSR8	8"

RING GASKET



Part	Size
02-RG2	2"
02-RG3	3"
02-RG4	4"
02-RG5	5"
02-RG6	6"
02-RG8	8"

BODY CASTING (THREADED & FLANGED AVAILABLE)



Part	Size
02-BodyV2	2"
02-BodyV3	3"
02-BodyV4	4"
02-BodyV5	5"
02-BodyV6	6"
02-BodyV8	8"

FV STRAINER SCREEN



Part	Size
02-SOV2	2"
02-SOV3	3"
02-SOV4	4"
02-SOV5	5"
02-SOV6	6"
02-SOV8	8"

FV BOTTOM DISK



Part	Size
02-BDV2	2"
02-BDV3	3"
02-BDV4	4"
02-BDV5	5"
02-BDV6	6"
02-BDV8	8"

FLANGE



Part	Size
02-F2	2"
02-F3	3"
02-F4	4"
02-F5	5"
02-F6	6"
02-F8	8"

STRAINER PARTS

RING CASTING



Part	Size
02-SR2	2"
02-SR3	3"
02-SR4	4"
02-SR5	5"
02-SR6	6"
02-SR8	8"

STRAINER SCREEN



Part	Size
02-SOS2	2"
02-SOS3	3"
02-SOS4	4"
02-SOS5	5"
02-SOS6	6"
02-SOS8	8"

STRAINER SCREEN NUT & BOLT



Part	Size
02-SBS2	2"
02-SBS3	3"
02-SBS4	4"
02-SBS5	5"
02-SBS6	6"
02-SBS8	8"

STRAINER BOTTOM DISK



Part	Size
02-BDS2	2"
02-BDS3	3"
02-BDS4	4"
02-BDS5	5"
02-BDS6	6"
02-BDS8	8"

MISCELLANEOUS PARTS

SLEEVE CASTING



Part	Size
02-SLEEVE2	2"
02-SLEEVE3	3"
02-SLEEVE4	4"
02-SLEEVE5	5"
02-SLEEVE6	6"
02-SLEEVE8	8"

INTAKE COUPLER BOLT, NUT & WASHER



Part	Size
02-CB	All Sizes

FLANGE BOLT, NUT & WASHER



Part	Size
02-FB	All Sizes

FV SCREEN BOLT & NUT



Part	Size
02-SBV2	2"
02-SBV3	3"
02-SBV4	4"
02-SBV5	5"
02-SBV6	6"
02-SBV8	8"



NELSON BIG GUNS



For Pivots, Travelers & Solid Sets

<u>Applications</u>	<u>Models Available</u>	<u>Part #</u>
Irrigation	SR75	10-SR75-24
Waste Water	SR100	10-SR100-24
Pastures	SR150	10-SR150-24
Dust Control	SR200	10-SR200-24
Lumber	(All guns listed above are 24 Degree Trajectory)	
Mining	SR200 (27 Degree)	10-SR200-27
Arena & Sports Fields		

**Please specify the following when ordering a Nelson Big Gun:
Model #, Trajectory, Connection Size & Type and Nozzle Size & Type.**

NELSON BIG GUN NOZZLES



Taper Ring Nozzle Sets

- 10-TR75 (size-Taper Ring Only)
- 10-100TR (size)
- 10-150TR (size)

Not available for SR200

Set includes Cap, Body & One Taper Ring



Taper Bore Nozzles

Not available for SR75

- 10-100T (size)
- 10-150T (size)
- 10-200T (size)

Taper Bore Nozzle



Ring Nozzle Sets

Not available for SR75

- 10-100R
- 10-150R
- 10-200R

Set includes Cap, Body & Seven Rings



KOMET TWIN BIG VOLUME GUNS

For Pivots, Travelers & Solid Sets



<u>Applications</u>	<u>Models Available</u>	<u>Part #</u>
Irrigation	Twin Max PC-24	38-05010037
Waste Water	Twin 101 Ultra PC-24	38-05010279
Pastures	Twin 140 Ultra PC-24	38-05010254
Dust Control	Twin 160 Ultra PC-24	38-05010255
Lumber	Twin 202 Ultra PC-24	38-05010256
Mining	(All guns listed above are 24 Degree Trajectory)	
Arena & Sports Fields		

***** We also stock nozzles and replacement parts for the older Komet Pro and Plus Models *****

KOMET TAPER BORE NOZZLES

<u>Model</u>	<u>Nozzle Range</u>	<u>Nozzle Range</u>
Twin Max Nozzles	.39" - .94"	10mm - 24mm
Twin 101 Ultra Nozzles	.47" - 1.10"	12mm - 28mm
Twin 140 Ultra Nozzles	.63" - 1.34"	16mm - 34mm
Twin 160 Ultra Nozzles	.71" - 1.50"	18mm - 38mm
Twin 202 Ultra Nozzles	.87" - 1.77"	22mm - 45mm



WEBSTERMATIC QUICK-COUPLING RISER VALVES

Part #	Description
33-6-100-AG	Supports 6' riser of 1" pipe/Threads are 1" external
33-10-100-AG	Supports 10' riser of 1" pipe/Threads are 1" internal.
33-6-100-LAWN	Supports 6' riser of 1" pipe/Threads are 1" external. Includes cover.



Note: Other sizes and models are available upon request.

ALUMINUM TUBING RISERS



1" MPT x 3/4" FPT Zinc Alloy

Part #	Size
08-RAL-112-006	6"
08-RAL-112-012	12"
08-RAL-112-018	18"
08-RAL-112-024	24"
08-RAL-112-036	36"
08-RAL-112-048	48"
08-RAL-112-060	60"
08-RAL-112-072	72"

1" MPT x 1/2" FPT Zinc Alloy
(available upon request)



1" MPT x 1" MPT Zinc Alloy
(available upon request)

LIQUID FILLED PSI GAUGES

Part #	PSI
111-LPG060	0-60
111-LPG100	0-100
111-LPG160	0-160
111-LPG200	0-200
111-LPG300	0-300



PIPE PLUGS

Part #	Size
08-MFT-PL0-500	1/2"
08-MFT-PL0-750	3/4"
08-MFT-PL1-000	1"



PIPE COUPLINGS

Part #	Size
08-MFT-SL0-500	1/2"
08-MFT-SL0-750	3/4"
08-MFT-SL1-000	1"



BELL REDUCERS

Part #	Size
08-MFT-BE3-150	3/4" x 1/2"
08-MFT-BE1-150	1" x 1/2"
08-MFT-BE1-750	1" x 3/4"
08-MFT-BE1-210	1-1/4" x 1"



BUSHINGS

Part #	Size
08-MFT-BU3-150	3/4" x 1/2"
08-MFT-BU1-150	1" x 1/2"
08-MFT-BU1-750	1" x 3/4"
08-MFT-BU1-210	1-1/4" x 1"



WHIZ HEAD ROTARY SPRINKLER - Model # 1973



Features:

- Ideal for riser installation in planting areas.
- 1/2" female threaded inlet.
- Made of high-impact corrosion-resistant plastic.
- Stainless steel bearing and large orifice nozzle.



Whiz Head Performance		
PSI	GPM	Diameter
30	3.4	40'
40	3.9	40'
50	4.4	40'

WADE RAIN BRASS SPRINKLERS



- All sprinklers are double-nozzled.
- Nozzles are sold separately.
- Choice of various nozzles includes: range nozzles, spreader nozzles and spreader nozzle plugs.



RAINBIRD SPRINKLERS

These sprinklers are designed for a wide variety of applications such as pastures, dust control, solid set for sod farms, frost protection, vegetable crops, overtree and undertree systems and many more.



30H



80EHD

BRASS FULL CIRCLE SPRINKLERS

Model #	Description
14VH	1/2" Bearing
20JH	1/2" Bearing
30H	3/4" Bearing
14070	3/4" Bearing
70	1" Bearing
80EHD	1 1/4" Bearing



85EHD

BRASS PART CIRCLE SPRINKLERS

Model #	Description
Maxi-Bird (Plastic)	1/2" Bearing
25BPJ	1/2" Bearing
35A-TNT	3/4" Bearing
65PJ	1" Bearing
85EHD	1 1/4" Bearing



2045-PJ Maxi-Bird



FRANK W. MURPHY SAFETY GAUGES

Murphy Gauges are the result of years of human experience, skill and pride. A strong quality assurance plan involving an inspection team, skilled workers and you, provides the positive control and action needed for the high standards Murphy sets and you expect. From incoming materials, to blueprints, line assembly, final packaging and shipping: quality is assured...it's built into every instrument.



LOW PSI SAFETY GAUGE



Part #	Description
06-20P7-075	0-75 Low PSI
06-20P7-100	0-100 Low PSI
06-20P7-150	0-150 Low PSI
06-20P7-200	0-200 Low PSI
06-20P7-300	0-300 Low PSI

HI-LO PSI SAFETY GAUGE



Part #	Description
06-20P7-HL150	0-150 Hi/Lo PSI
06-20P7-HL200	0-200 Hi/Lo PSI

FUEL SHUT-OFF VALVE



Part #	Description
06-SV12	12V Solenoid Valve
06-SV24	24V Solenoid Valve

LOW / HIGH PSI GAUGE



Part #	Size
06-OPLC-100	0-100 Low/Hi PSI
06-OPLC-200	0-200 Low/Hi PSI
06-OPLC-300	0-300 Low/Hi PSI
06-PD-8183	Pulsation Dampener for OPL Gauges

TIME SWITCHES



Part #	Size
06-12T	0-12 Hour Timer (15 Minute Intervals)
06-24T	0-24 Hour Timer (30 Minute Intervals)

MAGNETIC SWITCHES



Part #	Description
06-117	Magnetic Switch
06-518APH	Magnetic Switch
06-822PH	Magnetic Switch

TEMPERATURE SAFETY GAUGE



Part #	Description
06-20T	Water Temp Gauge
06-20TH-320-4-M10	Air Temp Gauge

(Temperature gauges include 4.5' capillary tube.)

ENGINE PANELS



Part #	Description
06-75160	Gas Panel (Oil, Water, Pump)
06-WD300LV	Diesel Panel (Oil, Water, Pump)

LIQUID-FILLED PSI GAUGE
GLYCERINE-FILLED FOR LONG LIFE



Part #	Description
111-LPG030	0-30 PSI
111-LPG060	0-60 PSI
111-LPG100	0-100 PSI
111-LPG160	0-160 PSI
111-LPG200	0-200 PSI
111-LPG300	0-300 PSI

ENGINE OIL PRESSURE GAUGE



NO RESET BUTTON

Part #	Description
06-A20P7-150	150 PSI

OTHER CONTROL AND INSTRUMENT SOLUTIONS AVAILABLE UPON REQUEST.

CHAMPION
Cross Section



Part #	Size
13-100565	2"
13-100570	3"
13-100575	4"
13-100600	5"
13-100625	6"
13-100630	8"

FELTON/KROY
Cross Section



Part #	Size
13-101145	2"
13-101150	3"
13-101175	4"
13-101180	5"
13-101200	6"
13-101225	8"

**RAINWAY/
REDI-RAIN**
Cross Section



Part #	Size
13-103830	2"
13-103925	3"
13-103950	4"
13-103975	5"
13-103834	6"
13-103835	8"

GHEEN
Cross Section

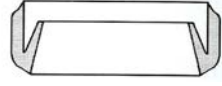

Part #	Size
13-102040	2"
13-102045	3"
13-102050	4"
13-102075	5"
13-102100	6"
13-102125	8"

PIERCE
Cross Section

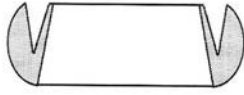

Part #	Size
13-103350	2"
13-103375	3"
13-103400	4"
13-103425	5"
13-103450	6"
13-103525	8"

RAIN CONTROL
Cross Section

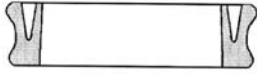

Part #	Size
13-103749	2"
13-103750	3"
13-103751	4"
13-103752	5"
13-103753	6"

**SHUR-RANE
(NEW STYLE)**
Cross Section



Part #	Size
13-105500	2"
13-105525	3"
13-105550	4"
13-105575	5"
13-105350	6"
13-105600	8"

**SHUR-RANE
(OLD STYLE)**
Cross Section



Part #	Size
13-105634	2"
13-105635	3"
13-105637	4"
13-105638	5"
13-105639	6"

RAVIT
Cross Section



Part #	Size
13-103842	2"
13-103843	3"
13-103844	4"
13-103846	6"

WADE
Cross Section



Part #	Size
13-106475	2"
13-106500	3"
13-106525	4"
13-106550	5"
13-106575	6"
13-106625	8"

WESTERN
Cross Section



Part #	Size
13-106300	2"
13-106325	3"
13-106350	4"
13-106375	5"
13-106400	6"
13-106425	8"

3/8" O-RINGS
Cross Section



Part #	Size
13-105482	2"
13-105483	3"
13-105484	4"
13-105485	5"
13-105486	6"

HASTINGS
Cross Section

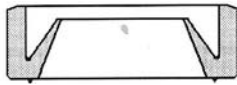

Part #	Size
13-102190	6"
13-102191	8"

**McDOWELL
SPRING**



Part #	Size
109-546-20	2"
109-546-30	3"
109-546-40	4"

McDOWELL
Cross Section



Part #	Size
109-446-20	2"
109-446-30	3"
109-446-40	4"
109-446-60	6"

RAINBOW
Cross Section



Part #	Size
13-103734	3"
13-103735	4"
13-103737	6"

Additional styles and sizes are available upon request.
 Large orders may qualify for special discount pricing.
 Please call for more information or visit our online store @ www.IrrigationSupplyParts.com.

45° ELBOW



Part #	Size
77-ZMG-L4507	1.5"
77-ZMG-L4508	2"
77-ZMG-L4510	3"
77-ZMG-L4511	4"
77-ZMG-L4513	6"

90° ELBOW



Part #	Size
77-ZMG-L9007	1.5"
77-ZMG-L9008	2"
77-ZMG-L9010	3"
77-ZMG-L9011	4"
77-ZMG-L9013	6"

TEE



Part #	Size
77-ZMG-T07	1.5"
77-ZMG-T08	2"
77-ZMG-T10	3"
77-ZMG-T11	4"
77-ZMG-T13	6"

45° STREET ELBOW



Part #	Size
77-ZMG-LST4507	1.5"
77-ZMG-LST4508	2"
77-ZMG-LST4510	3"
77-ZMG-LST4511	4"

90° STREET ELBOW



Part #	Size
77-ZMG-LST9007	1.5"
77-ZMG-LST9008	2"
77-ZMG-LST9010	3"
77-ZMG-LST9011	4"

COUPLING



Part #	Size
77-ZMG-CP07	1.5"
77-ZMG-CP08	2"
77-ZMG-CP10	3"
77-ZMG-CP11	4"
77-ZMG-CP13	6"

PLUG



Part #	Size
77-ZMG-PL07	1.5"
77-ZMG-PL08	2"
77-ZMG-PL10	3"
77-ZMG-PL11	4"
77-ZMG-PL13	6"

BUSHING



Part #	Size
77-ZMG-BU0805	2" x 1"
77-ZMG-BU0908	2.5" x 2"
77-ZMG-BU1008	3" x 2"
77-ZMG-BU1108	4" x 2"
77-ZMG-BU1110	4" x 3"

REDUCING COUPLING



Part #	Size
77-ZMG-CPR0805	2" x 1"
77-ZMG-CPR0908	2.5" x 2"
77-ZMG-CPR1008	3" x 2"
77-ZMG-CPR1108	4" x 2"
77-ZMG-CPR1110	4" x 3"

CAP



Part #	Size
77-ZMG-CA07	1.5"
77-ZMG-CA08	2"
77-ZMG-CA10	3"
77-ZMG-CA11	4"
77-ZMG-CA13	6"

THREADED HALF COUPLING (STEEL)



Part #	Size
03-P2062-09	2"
03-P2062-10	2 1/2"
03-P2062-11	3"
03-P2062-12	4"
03-P2062-13	5"
03-P2062-14	6"

UNION



Part #	Size
77-ZMG-UN07	1.5"
77-ZMG-UN08	2"
77-ZMG-UN10	3"
77-ZMG-UN11	4"

STEEL TOE NIPPLE



Part #	Size
03-P2127-15	1.5"
03-P2127-16	2"
03-P2127-24	3"
03-P2127-29	4"
03-P2127-35	6"
03-P2127-37	8"

STEEL CLOSE NIPPLE



Part #	Size
77-ZNB-07CL	1.5"
77-ZNB-08CL	2"
77-ZNB-10CL	3"
77-ZNB-11CL	4"
77-ZNB-13CL	6"
77-ZNB-15CL	8"

STEEL PLATED NIPPLE



Part #	Size
45-SPN150	1.5"
45-SPN200	2"
45-SPN300	3"
45-SPN400	4"
45-SPN600	6"
45-SPN800	8"

GALV RISER & VALVE STUB
Standard Tee Riser (MxF)

Part #	Size
03-P3828-06	4x4x4x42
03-P3829-06	6x6x4x42
03-P1239-26	6x6x6x42
03-P0008-33	8x8x6x42

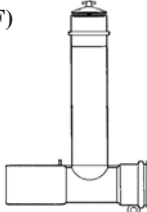

End Riser
(Cap End w/o Air Relief)

Part #	Size
03-P1252-26	4x4x42
03-P1254-26	6x4x42
03-P1255-26	6x6x42
03-P1257-26	8x6x42

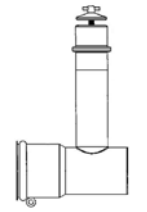

GALV RISER & VALVE STUB
Standard Tee Riser (FxF)

Part #	Size
03-P1220-26	4x4x4x42
03-P1223-26	6x6x4x42
03-P1224-26	6x6x6x42
03-P1227-26	8x8x6x42



End Riser
(Cap End w/ 2" Air Relief)

Part #	Size
03-P3345-25	4x4x42
03-P3395-25	6x4x42
03-P3341-26	6x6x42
03-P3340-26	8x6x42



GALVANIZED ZEE
Plain Top End

Part #	Size
03-P0114-93	4" x 52"
03-P0082-35	6" x 52"

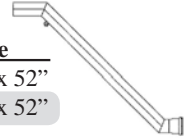

Flanged Top End

Part #	Size
03-P3735-01	4" x 52"
03-P3735-03	6" x 52"
03-P3735-04	8" x 52"



STRAIGHT TEE



Part	Size
03-P1457-29	4"
03-P1459-27	6"
03-P1459-33	8"

END PLUG



Part	Size
03-P1584-14	4"
03-P1584-16	6"
03-P1584-17	8"

END CAP



Part	Size
03-P1588-14	4"
03-P1588-16	6"
03-P1588-17	8"

CROSS



Part #	Size
03-P1495-21	4"
03-P1497-29	6"
03-P1497-32	8"

WELD-ON START COUPLER



Part	Size
03-P1001-24	4"
03-P1001-26	6"
03-P1001-27	8"

FLANGE ADAPTER

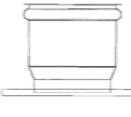

Part #	Size
03-P1143-94	4"
03-P1143-96	6"
03-P1143-97	8"

45° ELBOW

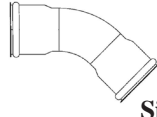

Part	Size
03-P1553-14	4"
03-P1555-21	6"
03-P1555-22	8"

90° ELBOW

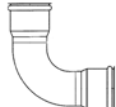

Part #	Size
03-P1552-14	4"
03-P1554-21	6"
03-P1554-22	8"

REPAIR COUPLER

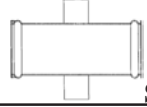

Part	Size
03-P1578-21	4"
03-P1578-22	6"
03-P1578-23	8"

COMPRESSION GASKETS - PVC



Part #	Size
03-P1603-01	4"
03-P1605-01	6"
03-P1606-01	8"

REDUCER (FxF)

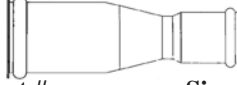

Part #	Size
03-P1527-28	6"x4"
03-P1527-30	8"x6"
03-P1527-31	10"x8"

AIR VENT



Part #	Size
03-F030-20003	2"

THRUST-BLOCKING PVC PIPE

- Water under pressure exerts thrust forces in piping systems at: changes in pipe size or direction, dead ends and valves.
- The design of thrust-blocking requires knowledge of the thrust generated and the bearing strength of the soil against which the thrust block will be placed.
- **To be effective, a thrust block must:**
 - a) be placed against undisturbed or fully compacted earth
 - b) contact the fitting over a sufficiently large area so as not to create stress points on the fitting
 - c) have sufficient area on the soil to restrain the thrust without exceeding the bearing strength of the soil

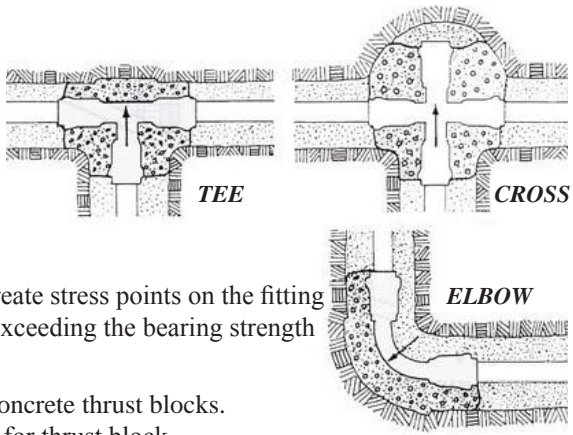

NOTES: 1) Supply line 3" in diameter and larger shall receive concrete thrust blocks.
2) See specifications for amount of concrete to be used for thrust block.

CAP (SOCKET) 

Part #	Size
26-447-007	3/4"
26-447-101	1"
26-447-020	2"
26-447-030	3"
26-447-040	4"
26-447-060	6"

CAP (FIPT) 

Part #	Size
26-448-007	3/4"
26-448-101	1"
26-448-020	2"
26-448-030	3"
26-448-040	4"
26-448-060	6"

PLUG (SOCKET) 

Part #	Size
26-449-007	3/4"
26-449-101	1"
26-449-020	2"
26-449-030	3"
26-449-040	4"
26-449-060	6"

PLUG (MIPT) 

Part #	Size
26-450-007	3/4"
26-450-101	1"
26-450-020	2"
26-450-030	3"
26-450-040	4"
26-450-060	6"

COUPLING (SOCKET x SOCKET) 

Part #	Size
26-429-007	3/4"
26-429-010	1"
26-429-020	2"
26-429-030	3"
26-429-040	4"
26-429-060	6"

FEMALE ADAPTER (FIPT x SOCKET) 

Part #	Size
26-435-007	3/4"
26-435-010	1"
26-435-020	2"
26-435-030	3"
26-435-040	4"
26-435-060	6"

MALE ADAPTER (MIPT x SOCKET) 

Part #	Size
26-436-007	3/4"
26-436-010	1"
26-436-020	2"
26-436-030	3"
26-436-040	4"
26-436-060	6"

Additional combinations and sizes available.
Please call for more details.

90° ELBOW (SOCKET x SOCKET) 

Part #	Size
26-406-007	3/4"
26-406-010	1"
26-406-020	2"
26-406-030	3"
26-406-040	4"
26-406-060	6"

90° ELBOW (FIPT x FIPT) 

Part #	Size
26-408-005	1/2"
26-408-007	3/4"
26-408-010	1"
26-408-012	1 1/4"
26-408-015	1 1/2"
26-408-020	2"

REDUCING BUSHING (SOCKET x SOCKET) 

Part #	Size
26-437-249	2" x 1"
26-437-338	3" x 2"
26-437-422	4" x 3"
26-437-530	6" x 3"
26-437-532	6" x 4"
26-437-585	8" x 6"

REDUCING BUSHING (SOCKET x FIPT) 

Part #	Size
26-438-248	2" x 3/4"
26-438-338	3" x 2"
26-438-420	4" x 2"
26-438-422	4" x 3"
26-438-530	6" x 3"
26-438-532	6" x 4"

REDUCING BUSHING (MIPT x FIPT) 

Part #	Size
26-439-072	1/2" x 1/4"
26-439-098	3/4" x 1/4"
26-439-101	3/4" x 1/2"
26-439-249	2" x 1"
26-439-292	2 1/2" x 2"
26-439-338	3" x 2"

90° ELBOW COMBINATION (SOCKET x FIPT) 

Part #	Size
26-407-005	1/2"
26-407-007	3/4"
26-407-010	1"
26-407-012	1 1/4"
26-407-015	1 1/2"
26-407-020	2"

45° ELBOW (SOCKET x SOCKET) 

Part #	Size
26-417-010	1"
26-417-015	1 1/2"
26-417-020	2"
26-417-025	2 1/2"
26-417-030	3"
26-417-040	4"
26-417-060	6"

CROSS (SOCKET) 

Part #	Size
26-420-010	1"
26-420-020	2"
26-420-030	3"

COUPLING (FIPT x FIPT) 

Part #	Size
26-430-005	1/2"
26-430-007	3/4"
26-430-010	1"

STREET 90° ELBOW (SOCKET x SPIGOT) 

Part #	Size
26-409-007	3/4"
26-409-010	1"
26-409-020	2"

STREET 90° ELBOW (SOCKET x MIPT) 

Part #	Size
26-410-007	3/4"
26-410-010	1"
26-410-020	2"

STREET 90° ELBOW (FIPT x MIPT) 

Part #	Size
26-412-007	3/4"
26-412-010	1"
26-412-020	2"

SLIP TEE (SLIP x SLIP x SLIP) 

Part #	Size
26-401-015	1 1/2"
26-401-020	2"
26-401-030	3"
26-401-040	4"

COMBINATION TEE (SLIP x SLIP x FPT) 

Part #	Size
26-402-015	1 1/2"
26-402-020	2"
26-402-030	3"
26-402-040	4"

THREADED TEE (FPT x FPT x FPT) 

Part #	Size
26-405-005	1/2"
26-405-007	3/4"
26-405-020	2"
26-405-030	3"

WYE (SLIP x SLIP x SLIP) 

Part #	Size
26-475-030	3"
26-475-040	4"
26-475-060	6"
26-475-080	8"

ADAPTER (PVC to FLEXIBLE PIPE) 

Part #	Size
26-474-007	3/4"
26-474-010	1"
26-474-020	2"
26-474-030	3"

TEE-REDUCING (SLIP x SLIP x SLIP) 

Part #	Size
26-401-249	2"x2"x1"
26-401-338	3"x3"x2"
26-401-422	4"x4"x3"
26-401-528	6"x6"x2"
26-401-530	6"x6"x3"
26-401-532	6"x6"x4"

COMBO TEE REDUCING (SLIP x SLIP x FPT) 

Part #	Size
26-402-247	2"x2"x1/2"
26-402-249	2"x2"x1"
26-402-335	3"x3"x1"
26-402-417	4"x4"x1"
26-402-420	4"x4"x2"
26-402-422	4"x4"x3"

ALL-PURPOSE CEMENT Medium Body 

Part #	Size
26-PVC05C-030	Quart

THREAD SEALANT Blue 75 

Part #	Size
26-SB75-030	Quart

ALL-PURPOSE CLEANER Purple Primer 

Part #	Size
26-PRIM70P-030	Quart

PVC TEE
(INSERT x INSERT x INSERT)



Part #	Size
26-1401-005	1/2"
26-1401-007	3/4"
26-1401-010	1"
26-1401-015	1 1/2"
26-1401-020	2"

PVC TEE
(INSERT x INSERT x FIPT)



Part #	Size
26-1402-005	1/2"
26-1402-007	3/4"
26-1402-010	1"
26-1402-015	1 1/2"
26-1402-020	2"

PVC TEE
(INSERT x INSERT x MIPT)



Part #	Size
26-1403-005	1/2"
26-1403-007	3/4"
26-1403-010	1"
26-1403-015	1 1/2"
26-1403-020	2"

PVC PLUG
(INSERT)



Part #	Size
26-1449-005	1/2"
26-1449-007	3/4"
26-1449-010	1"
26-1449-015	1 1/2"
26-1449-020	2"

PVC COUPLING
(INSERT x INSERT)



Part #	Size
26-1429-007	3/4"
26-1429-010	1"
26-1429-012	1 1/4"
26-1429-015	1 1/2"
26-1429-020	2"

PVC REDUCING 90° ELBOW
(INSERT x FIPT)



Part #	Size
26-1407-074	1/2"
26-1407-101	3/4"
26-1407-130	1"
26-1407-131	1 1/4"
26-1407-166	1 1/2"

PVC 90° ELBOW
(INSERT x INSERT)



Part #	Size
26-1406-010	1"
26-1406-012	1 1/4"
26-1406-015	1 1/2"
26-1406-020	2"
26-1406-030	3"

PVC MALE ADAPTER
(MIPT x INSERT)



Part #	Size
26-1436-005	1/2"
26-1436-007	3/4"
26-1436-010	1"
26-1436-015	1 1/2"
26-1436-020	2"

PVC FEMALE ADAPTER
(FIPT x INSERT)



Part #	Size
26-1435-005	1/2"
26-1435-007	3/4"
26-1435-010	1"
26-1435-015	1 1/2"
26-1435-020	2"

PVC REDUCING COUPLING
(INSERT x INSERT)



Part #	Size
26-1429-130	1" x 1/2"
26-1429-131	1" x 3/4"
26-1429-249	2" x 1"
26-1429-338*	3" x 2"
26-1429-0422	4" x 3"

* Fabricated

PVC 90° ELBOW
(INSERT x FIPT)



Part #	Size
26-1407-005	1/2"
26-1407-007	3/4"
26-1407-010	1"
26-1407-012	1 1/4"
26-1407-015	1 1/2"

PVC 90° ELBOW
(INSERT x MIPT)

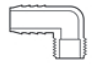

Part #	Size
26-1413-005	1/2"
26-1413-007	3/4"
26-1413-010	1"
26-1413-012	1 1/4"
26-1413-015	1 1/2"

PVC REDUCING 90° ELBOW
(INSERT x MIPT)



Part #	Size
26-1413-101	3/4" x 1/2"
26-1413-130	1" x 1/2"
26-1413-131	1" x 3/4"

PVC REDUCING MALE ADAPTER
(MIPT x INSERT)



Part #	Size
26-1436-102	3/4"x1"
26-1436-133	1"x1 1/2"
26-1436-251	2"x1 1/2"

WHITE PVC INSERT ADAPTER
(INSERT x IPS SPIGOT)



Part #	Size
26-460-020	2"
26-460-030	3"
26-460-040	4"

ADDITIONAL COMBINATIONS & SIZES AVAILABLE. PLEASE CALL FOR MORE DETAILS.

PVC REDUCING TEE
(INSERT x INSERT x INSERT)



Part #	Size
26-1401-130	1" x 1" x 1/2"
26-1401-210	1 1/2" x 1 1/2" x 3/4"
26-1401-247	2" x 2" x 1/2"
26-1401-249	2" x 2" x 1"
26-1401-251	2" x 2" x 1 1/2"

PVC REDUCING TEE
(INSERT x INSERT x FIPT)



Part #	Size
26-1402-166	1 1/4" x 1 1/4" x 1/2"
26-1402-211	1 1/2" x 1 1/4" x 1"
26-1402-247	2" x 2" x 1/2"
26-1402-249	2" x 2" x 1"
26-1402-251	2" x 2" x 1 1/2"

PVC REDUCING TEE
(INSERT x INSERT x MIPT)



Part #	Size
26-1403-130	1" x 1" x 1/2"
26-1403-131	1" x 1" x 3/4"

WHITE PVC INSERT ADAPTER
(INSERT x SOCKET)



Part #	Size
26-474-020	2"
26-474-030	3"
26-474-040	4"

PVC SCHEDULE 80 NIPPLE (THREADED BOTH ENDS)

Nipple Diameter	1/2"	3/4"	1"	1-1/4"	1-1/2"	2"	2-1/2"	3"	4"	6"	8"
Diameter Code	882	883	884	885	886	887	888	889	890	892	893
Nipple Length											
Close	-005										
2"	-020					N/A	N/A	N/A	N/A	N/A	N/A
3"	-030							N/A	N/A	N/A	N/A
4"	-040								N/A	N/A	N/A
6"	-060									N/A	N/A
8"	-080										
10"	-100										

Example: 887-060 is the part # for XX.

TUBING FOR IRRIGATION, INDUSTRY AND CONSTRUCTION



manufactured by

Hastings Irrigation Pipe Company

Aluminum Tubing is available in either coupled or bare pieces. Length options are 20', 30' or 40' as well as a wide variety of widths. Custom sizes are also available.

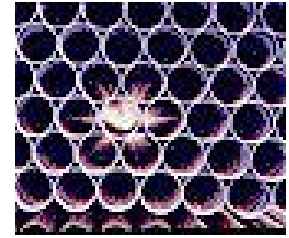

Call today for prices and availability on the aluminum tubing and PVC configurations that meet your irrigation needs!

A wide selection of USED and RECONDITIONED aluminum tubing is also available.



PVC PIPE

PVC pipe is tough, resilient, corrosion resistant inside and out, easy to handle and lasts longer than most other piping materials. It is ideal for almost any underground pipe application, such as rural water, agricultural and turf irrigation pipelines. The pressure rating of pipe - 100 psi through 200 psi indicates the maximum allowable sustained pressure with a long-term 2 to 1 safety factor. Most sizes can be handled manually, so there is no need for costly installation equipment. A trencher or backhoe are used for excavating and backfilling only, as the pipe can be slid together by hand, quickly and quite easily. PVC pipe can be curved slightly to eliminate many corners that would otherwise require elbows and thrust blocks.

We stock several styles of fittings for both aluminum tubing and PVC Pipe:

Aluminum Tubing Fittings - See Page 25

Steel Fittings for PVC (IPS) - See Page 37

Schedule 40 PVC Pipe Fittings - See Page 38

PVC Insert Fittings - See Page 39

Irrigation Worksheet

Name _____

Address _____

City _____

Phone # _____

Fax # _____

E-Mail _____

Best Time to Call _____

- New System Expansion

A. Irrigation Application

- Livestock Waste
- Municipal Waste
- Athletic Fields
- Golf
- Nursery
- Pasture
- Dust Control
- Produce
- Grain
- Other _____

B. Type of Irrigation Equipment Needed

- Drip Traveling Gun
- Pivot Wheel Line
- Solid Set

C. Source of Water

- Well Creek
- River Lagoon
- Pond

D. Type of Pump Required

- Diesel
- PTO
- Tractor HP Available PTO PRM 1000 540
- Propane
- Electric - Single Phase 3 Phase
- Submersible
- Gas

E. Frost Protection Required

- Yes No

F. If Expanding, List Present Equipment

G. Comments Pertaining to Existing Equipment

H. Financial Information

1. Budget for Project _____
 2. Type of Finance Lease Rent Cash
 3. Have you leased in the past yes no
- If so, with which company _____

I. Briefly Describe Irrigation Site

1. Soil Type _____
2. Terrain Elevation _____
3. Water Source Location / Distance _____
4. Row Width _____ Row Length _____
5. Plant Spacing In Row _____
6. Row Direction (in relation to N-S-E-W) _____
7. Acres Planning to Irrigate _____
8. Future Acres Expansion Projects _____

J. If possible, please send aerial photo with correct scale or include a sketch of the area you wish to have a system designed for.

Please mail or fax completed Irrigation Worksheet to:

Triple K Irrigation Inc

12930 Ingall Highway

Morenci, MI 49256

Fax # (517)458-6541



Irri-Gator

Drip Irrigation For Your Garden!

- Uses up to 75% less water
- Eliminates leaf wetness
- Water goes directly to the root zone
- Reduces plant disease

Gator Kit Sample Layout

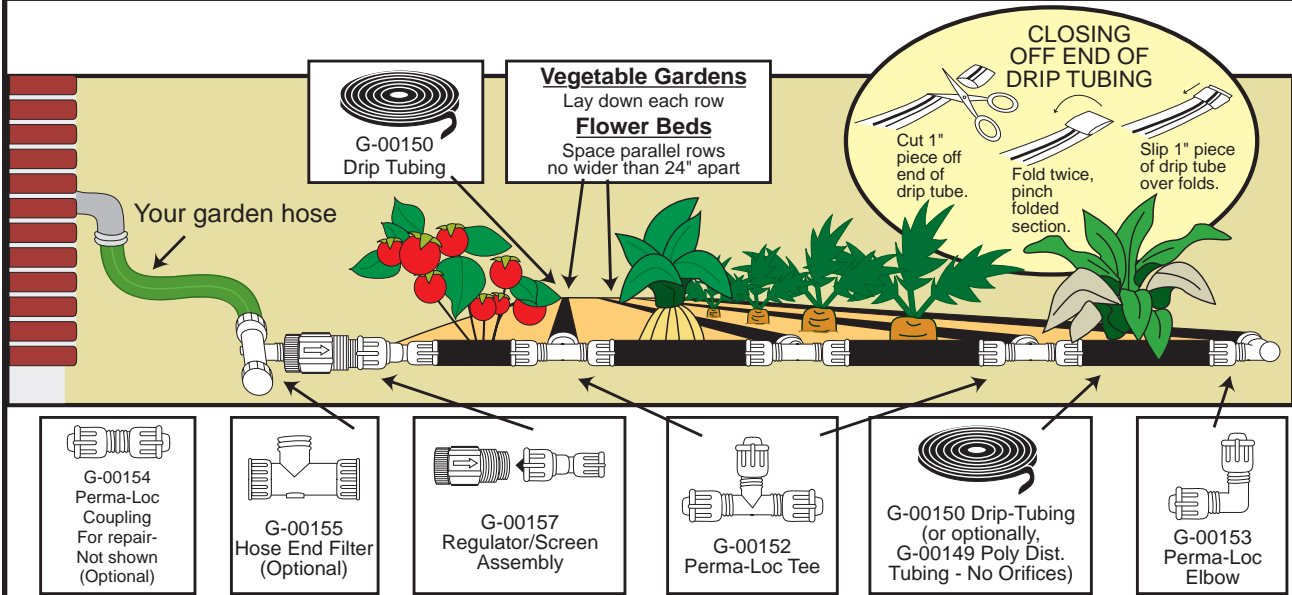

Gator 100 Kit: Fits a vegetable garden with 4 - 22' rows spaced up to 4' apart, or a flower bed of up to 200 square feet.
 Gator 250 Kit: Fits a vegetable garden with 6 - 38' rows spaced up to 4' apart, or a flower bed of up to 500 square feet.
 Gator 1000 Kit: Fits a vegetable garden with 10 - 100' rows spaced up to 5' apart, or a flower bed of up to 2,000 sq feet.

Irri-Gator Garden Kits Contain:

Description	Gator 100	Gator 250	Gator 1000
Drip Tubing (12" spacing)	100'	250'	1,000'
Distribution Tubing (no orifices)	-	-	50'
Perma-Loc Tee	3	5	8
Perma-Loc Elbow	1	1	2
Perma-Loc Coupling	-	1	2
Regulator/Screen Assembly	1	1	-
Regulator/Tee Screen Assembly	-	-	1
Installation Instruction Sheet	1	1	1



Please visit our on-line store at www.GardensGrownRight.com to:

- View an instructional video which demonstrates the simplicity of installing our Irri-Gator Drip Irrigation Kits
- Learn more information about the benefits of drip irrigation
- Purchase a variety of gardening tools in addition to our Irri-Gator Drip Irrigation Kits and Accessories
- Access a printable copy of our Irrigation Worksheet in PDF format to allow us to assist you in designing your drip system when customization is necessary.

BLUE-WHITE'S DIGI-FLO® F-1000

Battery Powered Model F-1000 Benefits Include:

- Easy to read 6-digit LCD display
- Installs quickly on existing pipe
- Factory calibrated, nothing to program
- No pressure drop
- Weather resistant ABS enclosure
- Corrosion resistant PVDF sensor
- Excellent accuracy
- Large calibrated flow range
- Minimal maintenance required
- Flow ranges: 15-4000 gpm
- Sizes: 1-1/2" - 8"



The carefully engineered DIGI-FLO® F-1000 Series provide the performance and features of electronic meters without the need for a electrical hook-up.

Three versions of this terrific meter are offered:

- 1) The F-1000RB is a battery powered rate meter.
- 2) The F-1000TB is a battery powered flow totalizer.
- 3) The F-1000RT is a battery powered rate meter and flow totalizer.

Two standard AAA batteries with a minimum life of one year power each of these units.

Additional meters are available upon request

FLOMEC'S QS200 INSERTION ULTRASONIC FLOWMETER

The QS200 Insetion Ultrasonic Flowmeter provides an accurate reading of liquid flow rate and accumulated flow. Designed to support commercial irrigation applications, the QS200 is available in five pipe sizes, 1 to 4 in. The QS200 ultrasonic insert is available with a PVC tee or as an "insert retrofit" for replacement of existing paddlewheel flow sensors.

QS200 Ultrasonic Specifications

Designed for above and below grade applications, such as irrigation, municipal and underground monitoring where the flow rates are between 0.1 to 15 fps (0.03 to 4.57 m/s) and temperatures are below 140°F. QS200 inserts are supplied with two single conductors, 18 AWG solid copper wire leads that are 36 inches in length with UL Style 116666 direct burial insulation.



BLUE-WHITE'S F-300 SERIES FLOWMETER

- Determine Circulation System flow rate in seconds
- Installs quickly
- One piece machined acrylic meter body - polished to a clear finish
- Easy to read, high resolution dual scale, permanently printed
- Read flow from either side of the meter body
- Ships complete with gasket seal and mounting clamps

F-300 Specifications

Max. Working Pressure: 75 PSI @ 70°F
 Meter Body Material: Acrylic
 Connection Type: Saddle
 Max. Fluid Temperature: 190°F @ 0 PSI
 Gasket Material: Neoprene
 Float Material: 316 SS



DOSATRON FERTILIZER INJECTOR

Dosatron fertilizer injectors can be used in a variety of installations and configurations. Mount them on booms or benches. Increase your flow with parallel installations, or inject multiple nutrients with series installations.

- Aquaponics
- Indoor Farming and Agriculture
- Stacked Farming
- Urban Gardening and Farming
- Drain-to-Waste



Part #	Connection Size	Flow	Dilution	OPR
148-D14MZ2VFII	3/4" NPT	0.05 to 14 GPM	.2% to 2%	4.3 to 85 PSI
148-D25F1VFII	3/4" NPT	0.05 to 11 GPM	1%	4.3 to 85 PSI
148-D8RE2	1 1/2" NPT	2.2 to 40 GPM	.2% to 2%	2.2 to 116 PSI
148-D45RE15	1" NPT	0.4 to 20 GPM	.2% to 1.5%	7 to 70 PSI

MAZZEI INJECTOR

Mazzei Injectors are high efficiency Venturi-type differential pressure injectors. A pressure difference between the inlet and outlet of the injector creates a vacuum inside the body, which results in suction through the suction port. The suction can be used to inject and mix fertilizers and water treatment chemicals into the water. Mazzei injectors not only are trouble-free because there are no moving parts, but also have long life because they are molded from chemical resistant polypropylene or PVDF.

Sizes range from 1/2" thru 4".



Typical Installation

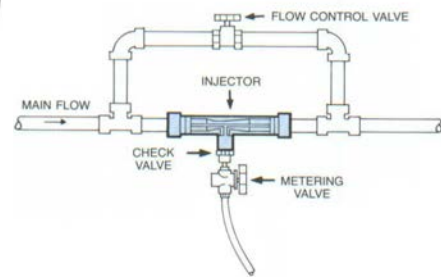

Please call for more product information, pricing and availability on any products listed in this catalog.

FLOW-GUARD VERTICAL SAND MEDIA FILTERS

Flow-Guard Media Filters provide outstanding filtration of both organic and inorganic materials found within common irrigation waters. Due to their ability to filter a wide variety of contaminants to very low levels, Flow-Guard Media Filters are widely used as primary filtration systems in drip and micro-irrigation systems all over the world.

As source water passes through a sand media filter, a wide variety of both organic and inorganic materials are captured in the media bed while allowing the now filtered water to pass through. Media comes in a variety of types and sizes.

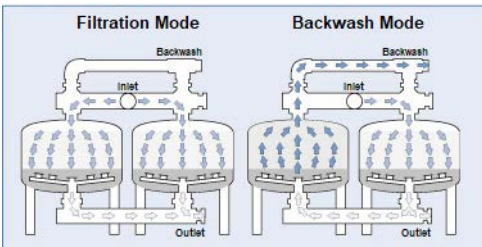

Depending on the media used, irrigation water from virtually any source can be filtered effectively. Backwashing or Backflushing refers to the removal of captured materials that have been effectively filtered out of the original source water. When the filtering media has captured enough material to cause the pressure differential between the inlet and the outlet of the filter to reach a predetermined level (or at specific timed intervals) the flow of water is reversed through the sand bed and the captured material is flushed out.



AMIAD FILTERS

Amiad offers a wide range of plastic and steel filters from 3/4" to 14". Interchangeable filter elements will suit specific needs depending upon flowrates, filtration degrees and applications. Simple and easy maintenance. All filter elements are extractable for cleaning. Minimal head loss even at high flow rates.



Scanaway Assembly



Brushaway Assembly

AMIAD MINI SIGMA AUTOMATIC SELF CLEANING FILTER

The flush valve opens to atmosphere creating a strong suction force at the scanner nozzles, effectively removing dirt particles from the screen and discharging them from the filter.

Part #	Size/Max Flow
133-055000-000002	2" for up to 110 GPM
133-055001-000003	3" for up to 220 GPM
133-055002-000018	4" for up to 352 GPM



Spin Clean® filters are unique in that incoming dirty water is forced through a directional nozzle plate onto the inside of the stainless steel screen. This creates a centrifugal action which rotates debris down the screen wall to the large holding basin. Debris is flushed out via a ball valve or unscrewing cap. Spinning action keeps more of the screen area clean, minimizing pressure losses caused by excessive dirt build-up. For optimum self-cleaning action, Spin Clean® filters should be operated at a flow rate that will create a 5 to 8 psi pressure drop across the filter.

PLASTIC SPIN CLEAN® SCREEN FILTERS (MPT w/ MPT Ball Valve)

Part #	Description	Max Flow
50-72130116	3/4" WYE 4EH Screen Filter	9 GPM
50-72130207	1" WYE 4EH Screen Filter	18 GPM
50-72130091	1 1/2" WYE 4EH Screen Filter	55 GPM
50-72130106	2" WYE 4EH Screen Filter	110 GPM

Note: These filters are available in 50, 100 and 150 mesh. Please specify when ordering. Part #'s above are for 150 mesh.

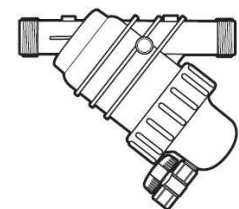

The ADI-P Controller

The ADI-P Controller operates the automated processes that flush your Sigma Pro filters, allowing you to control and monitor them easily and conveniently.



- Suitable for low pressure (1.5-10 bar)
- Single or dual solenoid configuration
- Provides detailed filtration performance data
- Communication within Bluetooth® technology range
- Offline information storage available

The ADI-P App

Access your site's filtration performance data directly from the adi-p app. Here are some of the data that you can access via the adi-p app:



- Flush logs
- Flush quality - measuring DP on the filter before and after flush cycle
- Flush frequency
- Malfunctions with descriptions of each event
- Current DP
- Battery status and low battery alerts
- Current outlet and inlet pressure

AMIAD SIGMA PRO MODELS

4" SIGMAPRO

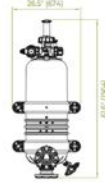

Head Loss Graph (in clean water)

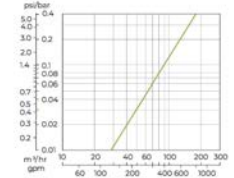

8" SIGMAPRO

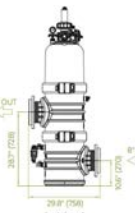

Head Loss Graph (in clean water)

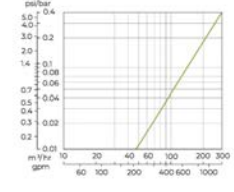

Apex PC Dripperline

Apex PC Dripperline Specification						
Tubing Size	ID	OD	Wall	PSI min	PSI max	Kd
16 mm	.550"	.640"	45 mil	7	60	0.87
18 mm	.620"	.710"	45 mil			0.52
20 mm	.710"	.805"	47.5 mil			0.33

Inlet Filter Surface Area		
Length	in	1.12
Width	in	0.20
Area	in ²	0.22
Slot Width	in	0.01

Apex Emitter Flow Rate	
Nominal	GPH flow
0.4	.425 gph
0.5	.564 gph
1.0	1.033 gph



Apex PC Dripperline Run Length in Feet

Distal Pressure 11 psi

18 mm 0.5 gph	18"	24"	30"	36"	42"	48"
12 psi	212	265	312	356	398	437
15 Psi	343	427	504	576	644	708
20 psi	454	566	668	764	854	939
25 psi	529	659	779	891	996	1095
35 psi	637	795	939	1075	1201	1322
50 psi	752	939	1112	1271	1422	1565

18 mm 1.0 gph	18"	24"	30"	36"	42"	48"
12 psi	142	176	208	237	265	291
15 Psi	228	285	336	384	429	472
20 psi	302	377	446	509	569	627
25 psi	352	439	519	594	664	731
35 psi	424	529	626	716	801	882
50 psi	501	626	741	848	949	1045

20 mm 0.5 gph	18"	24"	30"	36"	42"	48"
12 psi	277	342	402	457	510	559
15 Psi	447	554	651	741	825	906
20 psi	592	733	863	983	1096	1203
25 psi	690	855	1006	1146	1278	1403
35 psi	831	1031	1213	1382	1542	1694
50 psi	983	1219	1436	1637	1825	2006

20 mm 1.0 gph	18"	24"	30"	36"	42"	48"
12 psi	184	228	268	305	339	373
15 Psi	298	369	433	494	551	605
20 psi	395	489	576	656	731	802
25 psi	460	570	671	764	853	938
35 psi	554	687	809	923	1030	1131
50 psi	655	813	958	1093	1219	1338

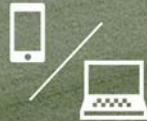

CONVENIENCE YOU DESERVE

Control and monitor your pivot irrigation systems with any Android, iOS, or web browser from anywhere.



ULTIMATE CONTROL NO ANNUAL FEES

Computer or Mechanical Panels—it doesn't matter. B-hyve AG is compatible with any Valley®, Zimmatic®, or Reinke® pivot panel.

(AG)

WATERMARK SOIL MOISTURE SENSOR

CAT #	CABLE LENGTH
200SS-5	5' (1.5 m)
200SS-5-S	5' (1.5 m)
200SS-15	15' (4.5 m)
200SS-15-S	15' (4.5 m)
200SS-X	6" (15 cm)
200SS-VA	Voltage Adapter
200SS-V-6	6 channel Galvanic Isolator
VTC	Vinyl Caps (bag of 100)

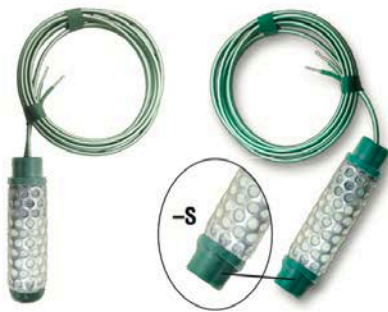

WATERMARK Soil Moisture Sensor for use with all crops in most soils. To be used with WATERMARK Meter, Monitor, Voltage Adapter or a compatible device. Reads electrical resistance in 0-200 centibar (cb) and kilopascal (kPa) range. Comes standard with half inch stripped and tinned ends. Ships in bulk. Pipe spigot end (-S) allows for installation on pipe, both top and bottom.

Galvanic isolation may be required for some reading devices. See 200SS-V-6.

WATERMARK METER

Solid state, digital hand-held, alternating current resistance bridge meter for reading standard WATERMARK Sensors. Adjustable for soil temperature variations. Touch pad operating panel with LCD display. Includes durable case, 9 volt battery and field replaceable cable assembly.



Only one meter is necessary to read multiple WATERMARK Sensors

CAT #	DESCRIPTION
30-KTCD-NL	WATERMARK Meter
30-KTCD-NL-SP	WATERMARK Meter with Spanish label and instructions
30-KTCD-Cable†	Replacement Cable

TAPE-LOC COUPLING



Part #	Size
50-12030062	5/8"
50-12030032	7/8"

TAPE-LOC x BARB



Part #	Size
50-12030004	5/8"x250B
50-12030002	5/8"x400B
50-12030015	7/8"x700B

TAPE-LOC w/ SHUT-OFF VALVE



Part #	Size
92-A2-TV5B250	250 Barb
92-A2-TV5B400	400 Barb

TAPE-LOC w/ SHUT-OFF VALVE



Part #	Size
92-A2-TV5LF	5/8" x Layflat

TAPE-LOC ELBOW



Part #	Size
92-A1-TE55	5/8"

TAPE-LOC TEE



Part #	Size
92-A1-TT555	5/8"

TAPE-LOC x 3/4" HOSE SWIVEL



Part #	Size
92-A1-T5SWW	5/8"

TAPE-LOC TEE x 3/4" HOSE SWIVEL



Part #	Size
92-A1-TT55SWW	5/8"

TAPE-LOC COUPLING VALVE



Part #	Size
92-A2-TV55	5/8"

TAPE-LOC x LAYFLAT HOSE



Part #	Size
92-A1-T5LF	5/8"

TAPE-LOC x MPT ADAPTER



Part #	Size
50-12030076	1/2" MPT
50-12030017	3/4" MPT

3/4" FPT x FHT SWIVEL ADAPTER



Part #	Size
26-AP-106	3/4"

GOOF PLUG



Part #	Size
50-12290034	250 Barb
50-12290035	400 Barb
50-12290037	700 Barb

PUNCH TOOL



Part #	Size
50-12071009	250 Barb
50-12070065	400 Barb

COMBO AIR RELEASE VALVE



Part #	Size
92-B5-VBK1C	2" MPT

TAPE-LOC x COMPRESSION



Part #	Size
50-12030030	5/8"x400C
50-12030033	5/8"x600C

Additional sizes and styles are available upon request.
Please see Page 45 for Blank Tubing & Dripper Line and Page 46 for Drip Tape.

POWER-LOC FITTINGS - Size Selection Chart Nominal Tubing Size 

Fitting Series #	Acceptable I.D.		Acceptable Wall Thickness	
	Inches	Millimeters	Inches	Millimeters
50	0.500 to 0.580	12.7 to 14.7	0.035 to 0.055	0.89 to 1.40
55	0.520 to 0.620	13.2 to 15.7	0.045 to 0.055	1.14 to 1.40
60	0.580 to 0.675	14.7 to 17.1	0.025 to 0.055	0.64 to 1.40
70	0.665 to 0.765	16.9 to 19.4	0.035 to 0.055	0.89 to 1.40
80	0.790 to 0.845	20.1 to 21.5	0.045 to 0.065	1.14 to 1.65
100	1.035 to 1.075	26.3 to 27.3	0.062 to 0.075	1.57 to 1.91

POWER-LOC COUPLING



Part #	Size
50-72050305	PL55
50-12050205	PL70
50-12050607	PL80
92-A1-HC1000	PL100

POWER-LOC TEE



Part #	Size
50-72050301	PL55
50-12050201	PL70
50-12050616	PL80
92-A1-HT111	PL100

POWER-LOC w/ SHUT-OFF VALVE



Part #	Size
50-72050314	PL55
50-12050223	PL70
92-A1-VHF88	PL80

POWER-LOC x 3/4" MHT ADAPTER



Part #	Size
50-72050311	PL55 x 3/4"
50-12050211	PL70 x 3/4"
50-12050604	PL80 x 3/4"
92-A1-H1H	PL100x 3/4"

**“SP” SERIES
FAN-JET
ASSEMBLED
WITH HAT**



Part #	Flow
150-8656	

**CHAPIN
SPRAY STICK &
TUBE ASSEMBLIES
FOR POTS**

(128x076-PE Tubing)



Part #	Length
50-12781312	12" Tube
50-12781318	18" Tube
50-12781324	24" Tube
50-12781330	30" Tube
50-12781336	36" Tube
50-12781342	42" Tube

**CHAPIN
SPRAY STICK &
TUBE ASSEMBLIES
FOR NURSERY
CONTAINERS**

(187x125-PE Tubing)



Part #	Length
50-12783418	18" Tube
50-12783424	24" Tube
50-12783430	30" Tube
50-12783436	36" Tube
50-12783448	48" Tube
50-12783472	72" Tube

**AQUA
SPRAY
STICKS**



Part #	Style
50-12501250	Black
50-12501251	Green
50-12501252	Avocado
50-12501253	Terra Cotta
50-12501254	Brown
50-12501255	Gray
50-12501256	Blue

**CLIK TIF BUTTON
EMITTER
Pressure
Compensating**



Part #	Description
<i>Check Non Leak Models (CNL)</i>	
50-12503205	0.5 GPH Brown
50-12503210	1.0 GPH Black
50-12503215	2.0 GPH Green
<i>Pressure Compensating Only</i>	
50-12503410	1.0 GPH Black
50-12503420	2.0 GPH Green

**WOODPECKER
DRIPPER
Pressure
Compensating**



Part #	Flow
<i>Woodpecker Junior Model</i>	
138-21000-001051	0.5 GPH
138-21000-001151	1.0 GPH
138-21000-001246	2.0 GPH
<i>Woodpecker Model</i>	
138-21020-001051	0.5 GPH
138-21020-001149	1.0 GPH
138-21020-001251	2.0 GPH

**MULTI-OUTLET
DRIPPER
ASSEMBLY**



Description
Flat 4-Way Manifold
Stackable 4-Way (Open End)
Long Straight Arrow Drinker
Angle Arrow Drinker

Please see
Page 49 for
Blank Tubing
and
Dripper Line

MANIFOLD VERSATILITY

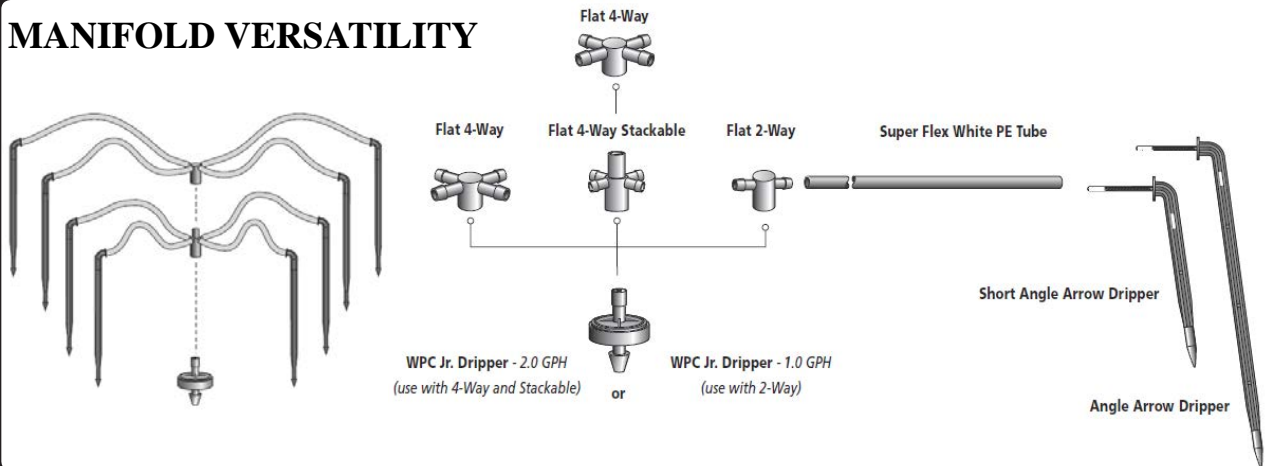

**SUPER 10 REVOLVER
Extra-Range,
Ball-Driven Sprinkler**



Part #	Nozzle	Flow Rate	PSI	Spacing
50-17135443	Blue	1.5 gpm	35	55 feet
50-17136446	Yellow	1.9 gpm	35	65 feet

Additional sizes and styles available upon request.

PRESSURE REGULATOR



Part #	Size	PSI	GPM
10-32PRV2-415V2K	2"	15	20-70 (4 Reg Units)
50-12100023	1"	15	2-20
50-12100041	1-1/4" x 1"	10	10-32

BLANK TUBING / SOLID TUBING



Part #	Dimensions (ID x OD)	Coil Length
50-11190149	0.187" x 0.125"	100' Roll
50-11190589	0.187" x 0.125"	1000' Roll
50-11190529	0.455" x 0.375"	100' Roll
50-11190531	0.455" x 0.375"	500' Roll
50-11190534	0.455" x 0.375"	1000' Roll

BLANK TUBING / SOLID TUBING



Part #	Dimensions (ID x OD)	Coil Length
50-11190541	0.455" x 0.375"	100' Roll
50-11190600	0.455" x 0.375"	1000' Roll
50-11200310	0.520" x 0.620"	100' Roll
50-11200311	0.520" x 0.620"	500' Roll
50-11200314	0.615" x 0.705"	500' Roll
50-11200316	0.817" x 0.927"	1000' Roll
50-11200340	1.174" x 1.050"	100' Roll

BUBBLER TUBING (DESIGNED FOR USE WITH OCTA-BUBBLER, QUADRA-BUBBLER & QB2 MANIFOLDS)



Part #	Description
50-71500155	100' Coil of POLY Bubbler Tubing banded with instructions
50-71500156	1000' Coil of POLY Bubbler Tubing on starburst reel
50-71500158	100' Coil of VINYL Bubbler Tubing banded with instructions
50-71500159	1000' Coil of VINYL Bubbler Tubing on starburst reel

PRESSURE COMPENSATING DRIPPER LINE (BLACK)



Size	Wall	Spacing	Flow Rate	Roll Length
18 mm	45 mil	18"	0.62	1,000'
18 mm	45 mil	24"	0.62	1,000'
18 mm	45 mil	24"	0.42	1,000'
18 mm	45 mil	36"	0.62	1,000'
20 mm	47 mil	18"	0.62	1,000'
20 mm	47 mil	24"	0.36	1,000'
20 mm	47 mil	24"	0.62	1,000'
20 mm	47 mil	36"	0.62	1,000'

OVAL HOSE



Part #	Size	PSI	Coil Length
50-11220086	1 1/2"	21	300'
50-11220081	2"	21	450'
50-11220082	3"	21	200'
50-11220083	4"	21	130'

DRIP IRRIGATION SPOOL OUT REEL



Part #
100-SpoolOutReel
Designed to spool out a roll of blank tubing or dripper line. Easy to use. Reel is adjustable and mountable.

XPANDO TAKE-OFF ADAPTOR



Part #	Size
119-45635	16mm x 16mm
119-45585	16mm x 18mm

CAPO RUBBER GROMMET



Part #	Size
119-45745	16mm
119-45755	19mm

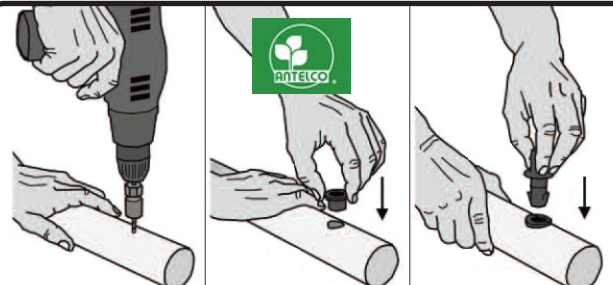

DRILL BIT FOR XPANDO TAKE-OFF FITTINGS



Part #	Size
65-10184A Bit	For 16mm & 18mm

FIGURE 8 TUBING END CLOSURE



Part #	Size (Tubing OD)
50-12290017	Up to 0.660"
50-12290018	Up to 0.720"
50-12290116	Up to 0.950"

RATCHET CLAMP



Part #	Size
119-44315	#22 (3/4")
119-44335	#18 (5/8")

Additional sizes and styles are available upon request

SALES TAX EXEMPTION CERTIFICATE

The undersigned purchaser claims to be legally entitled to exemption from sales tax on all (blanket) purchases made from Triple K Irrigation Inc (seller) by reason of one or more of the exemptions claimed below. The undersigned further agrees to reimburse the seller for any sales tax, penalties, and interest that may be assessed against the seller by reason of sales in accordance with this claimed exemption.

Please mail or fax Exemption Certificate to:

Triple K Irrigation Inc
12930 Ingall Highway
Morenci, MI 49256
Fax# (517)458-6541

EXEMPTION CLAIMED

Materials or Services Purchased for:

- _____ Resale and we will bill our customers for sales tax where applicable.
- _____ Industrial processing. The product sold or manufactured is: _____
- _____ Agricultural production.
- _____ Other (please specify) _____

Materials or Services Purchased by and for use by:

- _____ A church or house of religious worship, entitled to exemption, for use in activities, not mainly commercial enterprises. *
- _____ School - not operated for profit *
- _____ Hospital - not operated for profit *
- _____ Nonprofit Organizations certified through the state of _____ *
- _____ Government Agency *

* Certificate Number 2 applies

Certificate Number 1

The undersigned hereby certifies that all items, except as indicated hereon, are purchased for resale or for use or consumption in connection with the production of agricultural or industrial products as a business enterprise and agrees to report and pay sales tax on any items used or consumed internally. In the event that this claim is disallowed, the purchaser promises to reimburse the seller for any tax involved.

Certificate Number 2

The undersigned hereby certifies that the items being purchased are to be used or consumed in connection with the operation of the exempt institution or agency named in the space provided below and that the consideration of this purchase moves from the funds of the designated institution or agency. In the event that this claim is disallowed, the purchaser promises to reimburse the seller for any tax involved.

Company Name (purchaser)	Type of Business
Company Street Address	
Company City	State Zip Code
Sales Tax License Number	Date Exemption Began
Authorized Signature	Title Today's Date



Drip Tape



Dripper Line



Blank Tubing



Triple K Irrigation, Inc.
12930 Ingall Highway
Morenci, MI 49256



www.IrrigationSupplyParts.com

DRIP IRRIGATION



WASTE HANDLING



GREEN HOUSE



ORCHARDS



OVERHEAD IRRIGATION



INDUSTRIAL

